

Griplok® Tube Fittings

Quality
Instrumentation
Fittings

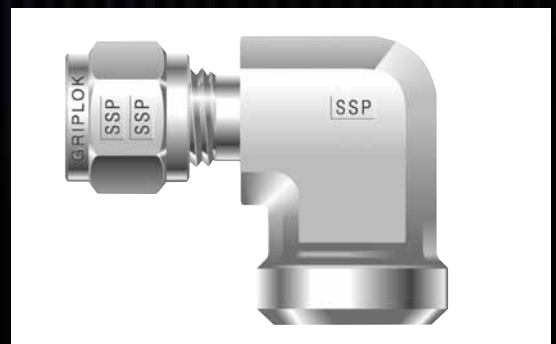

Company Information

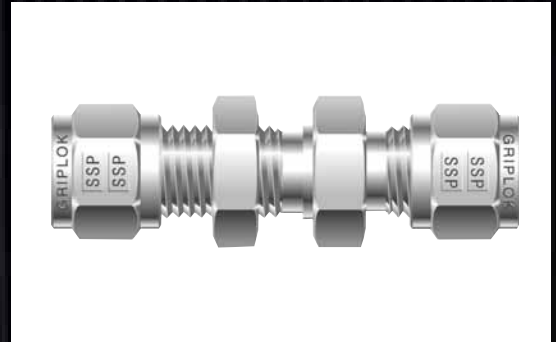
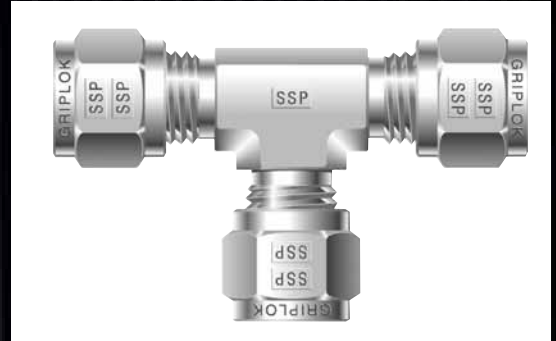
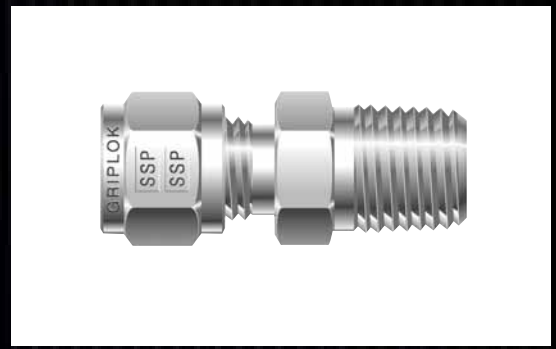

1926 SSP Fittings Corp. is founded in Cleveland, Ohio, U.S.A. SSP begins as a contract manufacturer of screw machine products in brass and carbon steel to general industry.

1940s World War II shifts the company's focus to production of fittings for tubing, pipe, and hose. Following the war, SSP's customers are able to satisfy their own requirements without relying on outside companies for production. SSP contracts.



1970s New Focus. By the early 1970s, SSP embarks on a market & manufacturing driven strategy of producing quality fittings from difficult-to-machine alloys. The performance requirements of customers utilizing these materials in industries as diverse as marine, defense, offshore oil, and aerospace, drive SSP to establish both conformance quality standards, and service levels, which are significantly ahead of general industry at the time.

1980s The "Works". Things are really happening for SSP. The company establishes a product line and distribution channel for hydraulic fittings, which require significant investments in a new, state-of-the-art facility south of Cleveland. SSP builds a 165,000 sq. ft. facility to house our vertically-integrated "Works," including, by now, tool & die design & production, custom closed-die forging, machining, finishing operations, assembly and test. With over 200 work centers, SSP's Twinsburg "Works" is among the largest single-site facilities in the entire industry.



1990s Market Expansion. In response to continued customer requests for alternative product offerings in the Instrumentation fitting and valve marketplace, strategic plans were developed to design, manufacture and distribute American-manufactured, tube fittings and valves as direct alternatives to the registered trademark brands of Swagelok[®], Parker CPI[®] and Hoke Gyrolok[®]. SSP introduces fully-validated design alternatives under brand names Duolok[®], Unilok[®], Griplok[®] tube fittings; TruFit[®] pipe, weld, hose and adapter fittings; and FloLok[®] valves.



2000 The New Force. SSP becomes the fastest-growing specialty fitting manufacturer in the United States selling through independent distributors.

With an established, efficient US distribution network in place, SSP expands into global markets with additional fabricated products including tubular and hose assemblies.

Significant continued investments allow SSP to renew our commitment to providing customers with best value through time-based competitive advantage, maximum objectivity in our product recommendations based on mastery over an ever-increasing range of fluid system fitting designs, and a commitment to integrity and honesty in our business relationships.



Swagelok[®] and Cajon[®] are registered trademarks of Swagelok Co.
Parker CPI[®] and Parker[™] are registered trademarks of Parker Hannifin.
Hoke Gyrolok[®] and Hoke[®] are registered trademarks of Hoke Inc.
Duolok[®], Unilok[®], Griplok[®], TruFit[®] & FloLok[®] are registered trademarks of SSP Fittings Corp.
Viton[®] and Teflon[®] are registered trademarks of E.I. duPont Nemours and Co.
Monel[®] is a registered trademark of Inco Alloys International

NOTICE: This publication is an uncontrolled copy of a controlled document. SSP has made every reasonable effort to insure the accuracy of the information contained in this publication, and is not to be held liable in any manner for any mistakes, omissions, typographical and/or printing errors.

How to Order Griplik Tube Fittings

Griplik tube fittings are ordered by specifying part numbers as listed in this catalog. The Griplik part numbers are easy to understand, and describe tube fittings that are completely assembled and ready to be installed. The following explains the part numbering system:

Example: ISSG4MC2

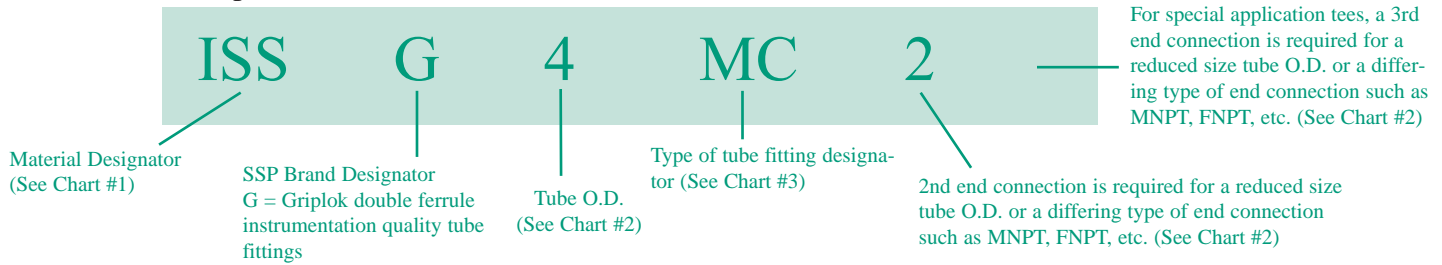

NOTES:

All Configurations: Only one size indicator is necessary when all of the connections are the same type and size.

Straights and Elbows: Specify the tube end first followed by the smaller tube end or differing type of connection (MNPT, FNPT, etc.)

Tees and Crosses: Tees are described by first sizing the run (1 to 2) and then the branch (3). Crosses are described by first sizing the run (1 to 2) and then the branch (3 to 4). See figure 1.

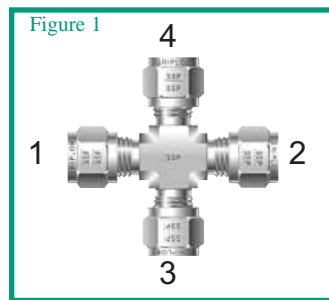

Specials: SSP Instrumentation manufactures a wide variety of special application tube fittings. Contact your local distributor for details regarding availability of special tube fitting configurations, materials and sizes.

CHART #1	
Instrumentation Materials Designator	Material
IB	Brass
ISS	316 Stainless Steel
IM	Monel®
IPFA*	PFA Teflon®
ITFE*	PTFE Teflon®
IN*	Nylon

* Ferrules Only

CHART #2 Part # Size Designators	
Size Desgn.	Tube O.D. or MNPT, FNPT Size*
1	1/16"
2	1/8"
3	3/16"
4	1/4"
5	5/16"
6	3/8"
8	1/2"
10	5/8"
12	3/4"
16	1"

*Tube O.D. expressed in sixteenths of an inch

CHART #3	
Type of Fitting Designator	Description of Griplik Tube Fitting Types
ANA	AN Adapter
ANBU	AN Bulkhead Union
ANF	Female AN Adapter
ANU	AN Union
BFC	Bulkhead Female Connector
BMC	Bulkhead Male Connector
BR	Bulkhead Reducer/Adapter
BRU	Bulkhead Reducing Union
BU	Bulkhead Union
CP	Cap
CU	Calibration Union
DA	Dielectric Adapter
DU	Dielectric Union
FA	Female Adapter
FBT	Female Branch Tee
FC	Female Connector
FCRT	Female Connector to ISO Tapered
FE	Female Elbow
FRT	Female Run Tee
HBA	Hose Barb Adapter
HBC	Hose Barb Connector
MA	Male Adapter
MAST	Male Adapter Straight Thread
MBT	Male Branch Tee
MBTST	Male Branch Tee Straight Thread
MC	Male Connector
MCBT	Male Connector Bored Through
MCRS	Male Connector to ISO Parallel
MCRT	Male Connector to ISO Tapered
MCST	Male Connector Straight Thread
ME	Male Elbow
MERT	Male Elbow to ISO Tapered
MEST	Male Elbow Straight Thread
M45EST	Male 45° Straight Thread Elbow
M45E	Male 45° Elbow
MPWE	Male Pipe Weld Connector
MPWE	Male Pipe Weld Elbow
MRT	Male Run Tee
MRTST	Male Run Tee Straight Thread
OMC	O Ring Seal Male Pipe Connector
OSC	O Ring Seal Straight Thread Connector
P	Plug
PC	Port Connector
R	Reducer/Adapter
RPC	Reducing Port Connector
RU	Reducing Union
TSWE	Tube Socket Weld Elbow
TSWU	Tube Socket Weld Union
U	Union
UCS	Union Cross
UE	Union Elbow
UT	Union Tee
COMPONENTS	
BN	Bulkhead Nut
FF	Front Ferrule
FS	Ferrule Set
KN	Knurled Nut
N	Nut
RF	Rear Ferrule
TI	Tube Insert

Griplok Tube Fittings

DESIGN

Griplok tube fittings are designed and manufactured to provide a reliable, leak-proof connection in instrument and process tubing systems.

Griplok tube fittings consist of four precision-machined components:

- 1) Body
- 2) Front Ferrule
- 3) Rear Ferrule
- 4) Nut

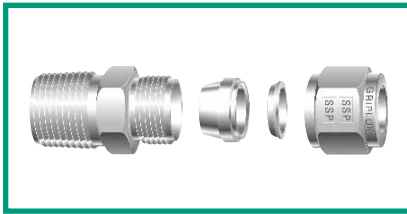

During make-up, the controlled drive action of the ferrules compensates for variations in tubing materials, hardness, and thickness of the tube wall to provide leak-tight connections in an extensive range of applications.

Additionally, in fulfillment of the design criteria, all **Griplok** components are manufactured with stringent tolerances and superior surface finishes to rigorous quality control standards to assure the optimum performance of each component.

OPERATION

Through critical interaction of precision-machined fitting components with the process tube, a leak-tight seal is achieved.

The simple geometric rotation of the **Griplok** nut provides the axial thrust necessary to "coin" the ferrules to the outside diameter of the tube. To eliminate any potential stress on an existing system, the tube fittings have been designed to not transmit installation torque from the tube fittings to the tube.

During the rotary movement of the nut, the internal surface of the nut meets with the rear surface of the rear ferrule to axially move the rear ferrule forward against the back radius of the front ferrule.

Simultaneously, the front ferrule is driven forward into the angular section of the fitting body to form a primary metal-to-metal seal. The rear ferrule roll-in locking action occurs on the outside diameter of the tube to complete the sealing action and secure the tube within the fitting.

The controlled ferrule drive prevents body distortion and helps compensate for exposure to system variables such as vibration, pressure pulsation and thermal expansion or contraction.

QUALITY

SSP's Quality System has been certified to conform to the **ISO 9001:2000 Quality Standard**. Achievement of this prestigious status further confirms SSP's continuing commitment to quality which is reflected throughout the company in its personnel, policies, equipment, products and service.



In addition, all **Griplok** tube fittings are manufactured to the technical design specifications and rigid quality control standards of the SSP Instrumentation Division.

Statistical Process Control techniques are employed within the manufacturing process to assure timely, meaningful feedback to the production team. Attention to detail, through continual process monitoring and control, provides the necessary manufacturing quality for the **Griplok** instrumentation tube fittings.

PACKAGING

Griplok tube fittings are individually bagged to assure the highest levels of quality, safety and cleanliness. The protective bags eliminate contamination (tubing burrs, dirt, etc.) from entering the fitting prior to its use, and help to retain the integrity of the factory assembled body, nut, and ferrules.



As long as a **Griplok** tube fitting is in its original protective bag, it is identified as "factory new," completely assembled and ready for installation.

The individually bagged **Griplok** tube fittings are packaged in convenient, small-lot quantities for easy procurement and handling. Additionally, for efficient product identification and storage, the boxes are color-coded to the tube fittings' material of construction and have pictorial labels which include the part number, product description and box quantity.

MATERIALS

316 STAINLESS STEEL

Griplok straight configuration tube fittings are machined from type 316 stainless steel cold-finished bar stock in accordance with ASTM A-479. Shaped bodies are machined from close-grained 316 stainless steel forgings in accordance with ASTM A-182. All 316 stainless steel Griplok components are heat code traceable with certified material test reports (CMTRs) available.

BRASS

Griplok straight configuration tube fittings are machined from CA360 and CA345 premium brass bar stock in accordance with ASTM B-16 and ASTM B-453. Shaped bodies are machined from precision forgings of CA-377 brass in accordance with ASTM B-124.

PRESSURE RATINGS

Generally, **Griplok** tube fittings are rated for pressures equal to the maximum allowable working pressures of the tubing recommended for use with the fittings. However, it is important to note that many specially designed fittings, bored-through fittings and fittings having AN, O-Seal and SAE/MS integral ends may have lower pressure ratings than that of the tubing. (See SSP's Selection Guide for Instrumentation Fittings and Tubing on pages 50-53 or contact your local Authorized Distributor for more information regarding tubing and fitting pressure ratings.)

TEMPERATURE FACTORS

Griplok tube fittings function reliably in applications ranging from cryogenic temperatures to high temperature bake out with the tube fitting material as the limiting factor. It is important to note that elevated temperatures may affect the maximum working pressure capability of the tubing system. (For more information regarding the effects of temperature on tubing pressure ratings, consult Table 5 regarding temperature stress factors in SSP's Selection Guide for Instrumentation Fittings and Tubing on pages 50-53.)

INTERCHANGEABILITY

Griplok tube fittings are designed, manufactured, quality controlled and distributed to be totally "interchangeable" with the Hoke Gyrolok[®] brand of tube fittings. Component examination plainly shows the two brands as completely "component-intermixable". The precision manufacturing of both products to stringent tolerances under rigid quality control procedures ensures the safety, performance and reliability of service whenever Hoke Gyrolok and **Griplok** component parts are mixed.

Additionally, **Griplok** tube fittings are considered able to be "functionally interchanged" with the Swagelok[®] brand of tube fitting. "Functionally interchanged" allows for the use of a **Griplok** nut and ferrule system with a Swagelok body, or a Swagelok nut and ferrule system with a **Griplok** body. The exceptional quality characteristics of both product lines assure complete product performance whenever the two brands are "functionally interchanged".

LIFETIME WARRANTY

Griplok tube fittings are covered by a published lifetime warranty as printed on the inside back cover of this catalog.

TUBE SELECTION

Careful selection and specification of tubing is essential to the performance of a tubing system. When choosing the appropriate tubing material, size and wall thickness, consideration must be given to the system's environment, pressures, temperatures and flows. (For more information on tube selection, please refer to SSP's Selection Guide for Instrumentation Fittings and Tubing on pages 50-53.)



Installation Instructions

INITIAL INSTALLATION

1. **Griplok** tube fittings come individually bagged and completely assembled for immediate use. There is no need for disassembly prior to use. Simply remove the tube fitting from its bag, insert the tube* until it bottoms in the **Griplok** tube fitting body and then hand tighten the **Griplok** nut. (See figure #1)

Figure #1



*Tubing ends should be cut as straight as possible with all O.D. and I.D. burrs removed. Use of a tubing cutter or guide blocks with a hacksaw is recommended.

[NOTE: For extreme system applications using high pressures or requiring an extra factor of safety, it may be desirable to use a “common make up starting point” to alleviate the inherent variations in tubing diameters. Installation should begin from a snug position, which is achieved by wrench tightening the **Griplok** nut until the inserted tubing will not move by hand (approximately 1/8 turn). From this new “snug” starting point, continue with the recommended installation instructions.]

2. While holding the fitting body stable with a back up wrench, scribe the nut for a reference point and wrench tighten the nut 1-1/4 turns. (See Figures #2 and #3.)

Figure #2

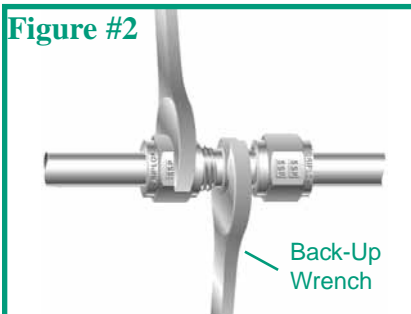
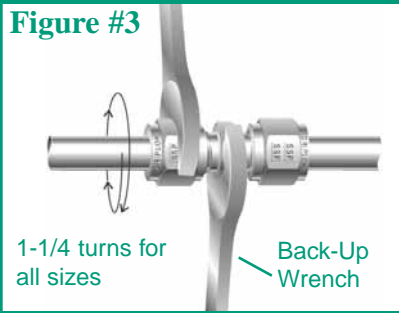

Figure #3



[NOTE: For all sizes, tighten plugs (P), machined ferrule end of port connector (PC) and the **Griplok** end of the Female AN adapter (ANF) only 1/4 of a turn.]

REASSEMBLY INSTRUCTIONS

1. To reassemble a **Griplok** tube fitting connection, simply insert the tubing with the previously coined ferrules and **Griplok** nut into the fitting body until the front ferrule seats within the fitting body, and then tighten the nut by hand. (See Figure #4.)

Figure #4

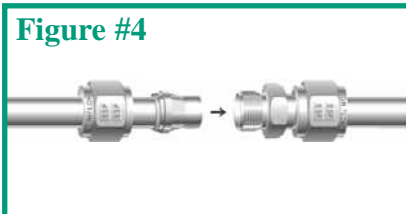

[NOTE: By following proper reassembly procedures, **Griplok** tube fitting connections may be disconnected and reconnected repeatedly.]

2. While holding the fitting body stable with a back up wrench, use a wrench to rotate the **Griplok** nut to the fitting's original installation position (approximately 1/4 turn from the hand-tight, snug position) then continue to tighten the **Griplok** nut slightly. (See Figure #5.)

Figure #5

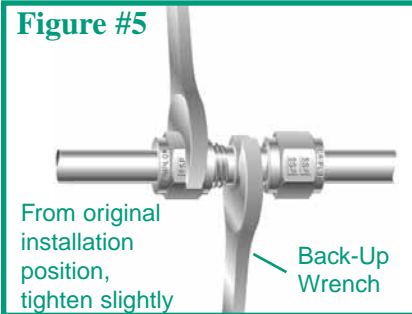

COMPONENT ASSEMBLY

Should individual component assembly of a **Griplok** tube fitting ever be required, careful attention must be given to the proper sequence and direction of the **Griplok** components. (See Figure #6.)

Figure #6

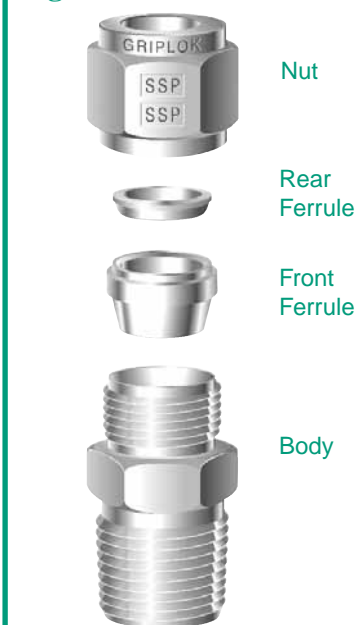

The **Griplok** pre-setting tool is used to pre-set the ferrules on the tubing for subsequent installation in a fitting body. The pre-setting tool can be especially helpful when an installation must be made in a tight space or hard-to-work area. The pre-setting tool allows the major portion of the installation work to occur in a more favorable work setting with only the completion of the installation in the hard-to-work area.

PRE-SETTING INSTRUCTIONS

1. Secure the pre-setting tool in a vise.
2. Remove the protective nut, and assemble the **Griplok** nut and ferrules loosely to the pre-setting tool. Insert the tubing through the nut and ferrules until it bottoms in the pre-setting tool, and then follow the standard **Griplok** tube fitting installation instructions from page 6. (See Figures #7A and #7B.)

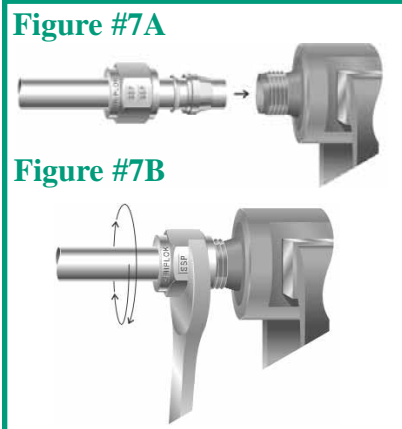

3. Loosen the nut and remove the tubing with the pre-set **Griplok** ferrules and nut from the pre-setting tool. (See Figure #8.)

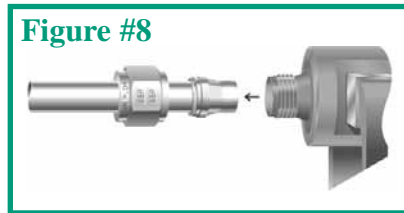





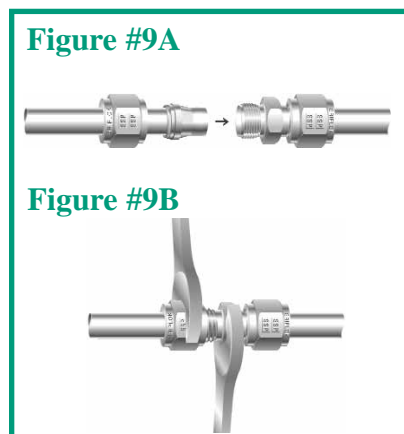





4. Installation of the tubing, with the pre-set **Griplok** ferrules and nut in the appropriate fitting body can now be made by following the standard reassembly instructions from page 6. (See Figures #9A and #9B.)

5. Return the protective nut to the pre-setting tool.









[NOTE: To extend the life of a pre-setting tool, lubricate the tool with a lubricant compatible with the system's tubing material, environment and media. Also, at times an oversized or very soft tubing may tend to stick in the pre-setting tool after make up. To remove the tubing, gently rock the tubing back and forth. Never turn the tube with pliers or another tool as such action may damage the sealing surfaces.]









Tube to Male Pipe

Male Connector 	Male Connector ISO Parallel 
MC 11	MCRS 12
Male Connector ISO Straight 	Male Connector Bored Through 
MCRT 13	MCBT 14
Bulkhead Male Connector 	Male Adapter 
BMC 15	MA 34
45° Male Elbow 	Male Elbow 
M45E 15	ME 16
Male Elbow ISO Tapered 	Male Branch Tee 
MERT 17	MBT 18
Male Run Tee 	
MRT 18	





Tube to Female Pipe

Female Connector 	Bulkhead Female Connector 	Female Adapter 
FC 19	BFC 20	FA 35
Female Run Tee 	Female Elbow 	Female Branch Tee 
FRT 21	FE 22	FBT 23









Tube to Tube Union

Union 	Bulkhead Union 	Reducing Union 	Union Elbow 
U 23	BU/BRU 24	RU 25	UE 26
Union Tee 	Reducing Union Tee 	Union Cross 	Dielectric Union 
UT 27	RUT 28	UCS 26	DA/DU 29





Tube to Welded System

<p>Tube Socket Weld Union</p>  <p>TSWU 30</p>	<p>Tube Socket Weld Elbow</p>  <p>TSWE 30</p>	<p>Male Pipe Weld Connector</p>  <p>MPWC 31</p>	<p>Male Pipe Weld Elbow</p>  <p>MPWE 31</p>
--	--	--	--









Tube Stub Connectors/Adapters

<p>Reducer/Adapter</p>  <p>R 33</p>	<p>Bulkhead Reducer/Adapter</p>  <p>BR 32</p>	<p>Port Connector</p>  <p>PC 36</p>	<p>Reducing Port Connector</p>  <p>RPC 36</p>
<p>Male Adapter</p>  <p>MA 34</p>	<p>Female Adapter</p>  <p>FA 35</p>	<p>Calibration Union</p>  <p>CU1/CU2 38</p>	<p>Hose Barb Adapter</p>  <p>HBA 37</p>
			<p>Hose Barb Connector</p>  <p>HBC 37</p>



Griplok to 37° Flare (AN)

<p>AN Union</p>  <p>ANU 39</p>	<p>AN Bulkhead Union</p>  <p>ANBU 39</p>
<p>Female AN Adapter</p>  <p>ANF 40</p>	<p>AN Adapter</p>  <p>ANA 40</p>







Tube to O-Ring Seal & SAE/MS

O-Ring Seal Male Connector  OMC 42	O-Ring Seal Male Connector  OSC 42
Male Connector to Straight Thread Boss  MCST 43	Male Elbow to Straight Thread Boss  MEST 44
45° Male Elbow to Straight Thread Boss  M45EST 44	Male Run Tee to Straight Thread Boss  MRTST 45
Male Branch Tee to Straight Thread Boss  MBTST 45	Male Adapter to Straight Thread Boss  MAST 46

Cap & Plug

Cap  CP 47
Plug  P 47

Components

Nut  N 48	Rear Ferrule  RF 48	Front Ferrule  FF 48	
Ferrule Set  FS 48	Knurled Nut  KN 49	Bulkhead Locknut  BN 49	Tube Insert  TI 49

Finger-tight assembly dimensions (shown in inches) are for reference only and subject to change.
When ordering specify material designator with part number (see page 3 for complete ordering information).

Tube to Male Pipe

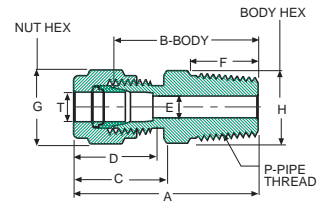

Male Connector (MC)

Griplok Part #	T Tube O.D.	P-NPT Male Pipe Size	A	B	C	D	E Minimum Opening	F Min.	G	H
G1MC1	1/16	1/16	1.00	0.79	0.49	0.40	0.05	0.38	5/16	5/16
G1MC2	1/16	1/8	1.09	0.88	0.49	0.40	0.05	0.38	5/16	7/16
G1MC4	1/16	1/4	1.28	1.07	0.49	0.40	0.05	0.56	5/16	9/16
G2MC1	1/8	1/16	1.23	0.91	0.66	0.56	0.09	0.38	7/16	7/16
G2MC2	1/8	1/8	1.26	0.94	0.66	0.56	0.09	0.38	7/16	7/16
G2MC4	1/8	1/4	1.46	1.14	0.66	0.56	0.09	0.56	7/16	9/16
G2MC6	1/8	3/8	1.47	1.15	0.66	0.56	0.09	0.56	7/16	11/16
G2MC8	1/8	1/2	1.72	1.40	0.66	0.56	0.09	0.75	7/16	7/8
G3MC2	3/16	1/8	1.28	0.97	0.68	0.59	0.12	0.38	1/2	7/16
G3MC4	3/16	1/4	1.48	1.17	0.68	0.59	0.12	0.56	1/2	9/16
G4MC1	1/4	1/16	1.33	1.00	0.74	0.64	0.12	0.38	9/16	1/2
G4MC2	1/4	1/8	1.33	1.00	0.74	0.64	0.19	0.38	9/16	1/2
G4MC4	1/4	1/4	1.53	1.20	0.74	0.64	0.19	0.56	9/16	9/16
G4MC6	1/4	3/8	1.55	1.22	0.74	0.64	0.19	0.56	9/16	11/16
G4MC8	1/4	1/2	1.80	1.47	0.74	0.64	0.19	0.75	9/16	7/8
G4MC12	1/4	3/4	1.86	1.53	0.74	0.64	0.19	0.75	9/16	1-1/16
G5MC2	5/16	1/8	1.34	1.05	0.73	0.64	0.19	0.38	5/8	9/16
G5MC4	5/16	1/4	1.52	1.23	0.73	0.64	0.25	0.56	5/8	9/16
G5MC6	5/16	3/8	1.54	1.25	0.73	0.64	0.25	0.56	5/8	11/16
G6MC2	3/8	1/8	1.44	1.10	0.81	0.71	0.19	0.38	11/16	5/8
G6MC4	3/8	1/4	1.62	1.28	0.81	0.71	0.28	0.56	11/16	5/8
G6MC6	3/8	3/8	1.62	1.28	0.81	0.71	0.28	0.56	11/16	11/16
G6MC8	3/8	1/2	1.87	1.53	0.81	0.71	0.28	0.75	11/16	7/8
G6MC12	3/8	3/4	1.93	1.59	0.81	0.71	0.28	0.75	11/16	1-1/16
G8MC2	1/2	1/8	1.60	1.13	0.93	0.97	0.19	0.38	7/8	13/16
G8MC4	1/2	1/4	1.78	1.31	0.93	0.97	0.28	0.56	7/8	13/16
G8MC6	1/2	3/8	1.78	1.31	0.93	0.97	0.38	0.56	7/8	13/16
G8MC8	1/2	1/2	2.00	1.53	0.93	0.97	0.41	0.75	7/8	7/8
G8MC12	1/2	3/4	2.06	1.59	0.93	0.97	0.41	0.75	7/8	11/16
G8MC16	1/2	1	2.32	1.85	0.93	0.97	0.41	0.94	7/8	13/8
G10MC6	5/8	3/8	1.78	1.34	0.90	1.00	0.38	0.56	1	15/16
G10MC8	5/8	1/2	1.97	1.53	0.90	1.00	0.47	0.75	1	15/16
G10MC12	5/8	3/4	2.03	1.59	0.90	1.00	0.50	0.75	1	1-1/16
G12MC8	3/4	1/2	2.03	1.59	0.90	1.00	0.47	0.75	1-1/8	1-1/16
G12MC12	3/4	3/4	2.03	1.59	0.90	1.00	0.62	0.75	1-1/8	1-1/16
G12MC16	3/4	1	2.29	1.85	0.90	1.00	0.62	0.94	1-1/8	1-3/8
G14MC12	7/8	3/4	2.03	1.59	0.90	1.06	0.62	0.75	1-1/4	1-3/16
G14MC16	7/8	1	2.29	1.85	0.90	1.06	0.72	0.94	1-1/4	1-3/8
G16MC8	1	1/2	2.34	1.78	1.12	1.31	0.47	0.75	1-1/2	1-3/8
G16MC12	1	3/4	2.34	1.78	1.12	1.31	0.62	0.75	1-1/2	1-3/8
G16MC16	1	1	2.53	1.97	1.12	1.31	0.88	0.94	1-1/2	1-3/8

Finger-tight assembly dimensions (shown in inches) are for reference only and subject to change.

When ordering specify material designator with part number (see page 3 for complete ordering information).

Fractional Tube to ISO Thread Fittings

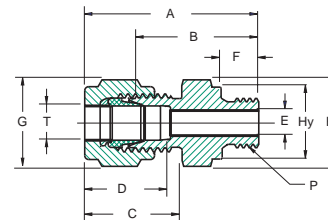

Male Connector - ISO Parallel (MCRS)

Griplok Part#	T Tube O.D.	P ISO Male Pipe	A	F	C	D	E	H Body Hex	Hy	G Nut Hex	B Body
G2MCRS2	1/8	1/8	1.18	0.28	0.60	0.50	0.09	9/16	0.54	7/16	0.92
G2MCRS4	1/8	1/4	1.39	0.44	0.60	0.50	0.09	3/4	0.71	7/16	1.13
G2MCRS6	1/8	3/8	1.43	0.44	0.60	0.50	0.09	7/8	0.86	7/16	1.17
G4MCRS2	1/4	1/8	1.27	0.28	0.70	0.60	0.16	9/16	0.54	9/16	0.98
G4MCRS4	1/4	1/4	1.48	0.44	0.70	0.60	0.19	3/4	0.71	9/16	1.19
G4MCRS6	1/4	3/8	1.53	0.44	0.70	0.60	0.19	7/8	0.86	9/16	1.24
G4MCRS8	1/4	1/2	1.76	0.56	0.70	0.60	0.19	1-1/16	1.02	9/16	1.47
G6MCRS4	3/8	1/4	1.54	0.44	0.76	0.66	0.23	3/4	0.71	11/16	1.25
G6MCRS6	3/8	3/8	1.59	0.44	0.76	0.66	0.28	7/8	0.86	11/16	1.30
G6MCRS8	3/8	1/2	1.82	0.56	0.76	0.66	0.28	1-1/16	1.02	11/16	1.53
G8MCRS4	1/2	1/4	1.68	0.44	0.86	0.90	0.23	13/16	0.71	7/8	1.28
G8MCRS6	1/2	3/8	1.70	0.44	0.86	0.90	0.31	7/8	0.86	7/8	1.30
G8MCRS8	1/2	1/2	1.93	0.56	0.86	0.90	0.41	1-1/16	1.02	7/8	1.53
G12MCRS8	3/4	1/2	1.93	0.56	0.86	0.96	0.47	1-1/16	1.02	1-1/8	1.53
G12MCRS12	3/4	3/4	2.08	0.62	0.86	0.96	0.62	1-5/16	1.26	1-1/8	1.68
G16MCRS8	1	1/2	2.20	0.56	1.04	1.23	0.47	1-3/8	1.02	1-1/2	1.72
G16MCRS16	1	1	2.36	0.72	1.04	1.23	0.78	1-5/8	1.54	1-1/2	1.88

NOTE: RS threaded fittings conform to ISO (International Standards Organization) standards 228/1. The standard gasket for RS fittings is a composite gasket. This gasket features a 300 series stainless steel outer ring with a Buna inner ring bonded to it.

Finger-tight assembly dimensions (shown in inches) are for reference only and subject to change.
When ordering specify material designator with part number (see page 3 for complete ordering information).

Fractional Tube to ISO Thread Fittings

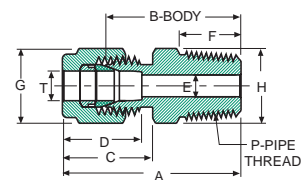
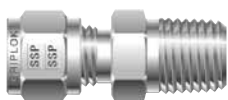

Male Connector - ISO Tapered (MCRT)

Griplok Part#	T Tube O.D.	P ISO Male Pipe	A	F	C	D	E Min. Opening	H Hex Flat	G Hex Flat	B Body
G2MCRT2	1/8	1/8	1.20	0.38	0.60	0.50	0.09	7/16	7/16	0.94
G2MCRT4	1/8	1/4	1.40	0.56	0.60	0.50	0.09	9/16	7/16	1.14
G4MCRT2	1/4	1/8	1.29	0.38	0.70	0.60	0.19	1/2	9/16	1.00
G4MCRT4	1/4	1/4	1.49	0.56	0.70	0.60	0.19	9/16	9/16	1.20
G4MCRT6	1/4	3/8	1.51	0.56	0.70	0.60	0.19	11/16	9/16	1.22
G4MCRT8	1/4	1/2	1.76	0.75	0.70	0.60	0.19	7/8	9/16	1.47
G5MCRT2	5/16	1/8	1.34	0.38	0.73	0.64	0.19	9/16	5/8	1.05
G5MCRT4	5/16	1/4	1.52	0.56	0.73	0.64	0.25	9/16	5/8	1.23
G6MCRT2	3/8	1/8	1.39	0.38	0.76	0.66	0.19	5/8	11/16	1.10
G6MCRT4	3/8	1/4	1.57	0.56	0.76	0.66	0.28	5/8	11/16	1.28
G6MCRT6	3/8	3/8	1.57	0.56	0.76	0.66	0.28	11/16	11/16	1.28
G6MCRT8	3/8	1/2	1.82	0.75	0.76	0.66	0.28	7/8	11/16	1.53
G8MCRT4	1/2	1/4	1.71	0.56	0.86	0.90	0.28	13/16	7/8	1.31
G8MCRT6	1/2	3/8	1.71	0.56	0.86	0.90	0.38	13/16	7/8	1.31
G8MCRT8	1/2	1/2	1.93	0.75	0.86	0.90	0.41	7/8	7/8	1.53
G8MCRT12	1/2	3/4	1.99	0.75	0.86	0.90	0.41	1-1/16	7/8	1.59
G12MCRT12	3/4	3/4	1.99	0.75	0.86	0.96	0.62	1-1/16	1-1/8	1.59
G16MCRT16	1	1	2.45	0.94	1.04	1.23	0.88	1-3/8	1-1/2	1.97

NOTE: RT threaded fittings conform to ISO (International Standards Organization) standards 7/1.

Tube to Male Pipe

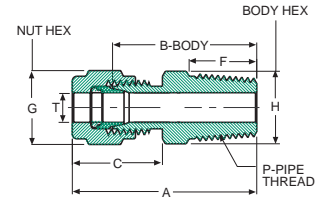

Male Connector - Bored Through (MCBT)

Griplok Part #	T Tube O.D.	P-NPT Male Pipe Size	A	B	C	F Min.	G	H
G1MCBT1	1/16	1/16	1.00	0.79	0.49	0.38	5/16	5/16
G1MCBT2	1/16	1/8	1.09	0.88	0.49	0.38	5/16	7/16
G2MCBT1	1/8	1/16	1.23	0.91	0.66	0.38	7/16	7/16
G2MCBT2	1/8	1/8	1.26	0.94	0.66	0.38	7/16	7/16
G2MCBT4	1/8	1/4	1.46	1.14	0.66	0.56	7/16	9/16
G3MCBT2	3/16	1/8	1.28	0.97	0.68	0.38	1/2	7/16
G3MCBT4	3/16	1/4	1.48	1.17	0.68	0.56	1/2	9/16
G4MCBT2	1/4	1/8	1.33	1.00	0.74	0.38	9/16	1/2
G4MCBT4	1/4	1/4	1.54	1.20	0.74	0.56	9/16	9/16
G4MCBT6	1/4	3/8	1.55	1.22	0.74	0.56	9/16	11/16
G4MCBT8	1/4	1/2	1.80	1.47	0.74	0.75	9/16	7/8
G5MCBT4	5/16	1/4	1.52	1.23	0.73	0.56	5/8	9/16
G6MCBT4	3/8	1/4	1.62	1.28	0.81	0.56	11/16	5/8
G6MCBT6	3/8	3/8	1.62	1.28	0.81	0.56	11/16	11/16
G6MCBT8	3/8	1/2	1.87	1.53	0.81	0.75	11/16	7/8
G8MCBT8	1/2	1/2	2.00	1.53	0.93	0.75	7/8	7/8
G10MCBT12	5/8	3/4	2.03	1.59	0.90	0.75	1	1-1/16
G12MCBT12	3/4	3/4	2.03	1.59	0.90	0.75	1-1/8	1-1/16
G16MCBT16	1	1	2.53	1.97	1.12	0.94	1-1/2	1-3/8

Thermocouple Connector

To accommodate thermocouples and other sensing probes, the MCBT series of fittings has been “bored through” to allow the thermocouple or sensor to extend beyond the end of the fitting’s NPT thread.

NOTE: Pressure Ratings of “bored through” tube fittings are reduced. For additional information on a specific fitting’s rating, contact your local distributor.

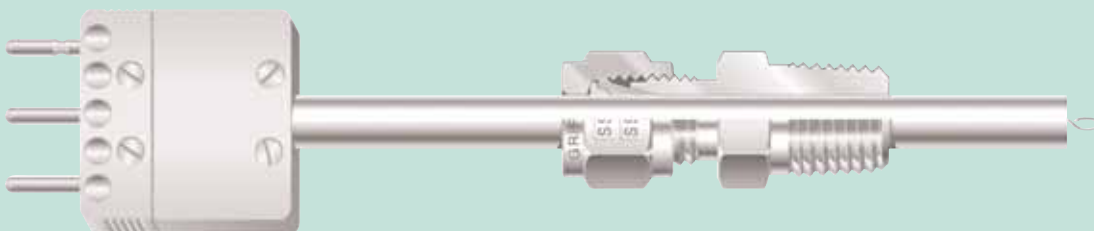

Finger-tight assembly dimensions (shown in inches) are for reference only and subject to change.
When ordering specify material designator with part number (see page 3 for complete ordering information).

Tube to Male Pipe

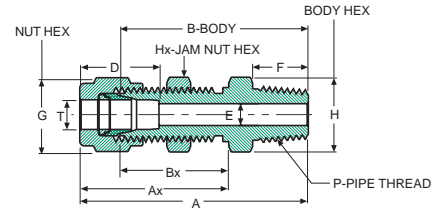
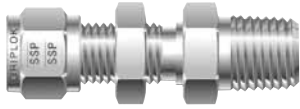

Bulkhead Male Connector (BMC)

Griplok Part #	T Tube O.D.	P-NPT Male Pipe Size	A	Ax	B	Bx	D	E Minimum Opening	F Min.	G	H	Hx	Maximum Panel Thickness	Panel Hole Drill Size
G2BMC2	1/8	1/8	1.89	1.23	1.57	0.97	0.56	0.09	0.38	7/16	1/2	1/2	0.50	21/64
G4BMC2	1/4	1/8	1.99	1.32	1.66	1.03	0.64	0.19	0.38	9/16	5/8	5/8	0.40	49/64
G4BMC4	1/4	1/4	2.14	1.32	1.81	1.03	0.64	0.19	0.56	9/16	5/8	5/8	0.40	49/64
G6BMC4	3/8	1/4	2.31	1.45	1.97	1.16	0.71	0.28	0.56	11/16	3/4	3/4	0.44	37/64
G8BMC6	1/2	3/8	2.56	1.65	2.09	1.25	0.97	0.37	0.56	7/8	15/16	15/16	0.50	49/64
G8BMC8	1/2	1/2	2.78	1.65	2.31	1.25	0.97	0.41	0.75	7/8	15/16	15/16	0.50	49/64

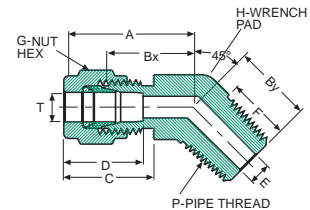

45° Male Elbow (M45E)

Griplok Part #	T Tube O.D.	P-NPT Male Pipe Size	A	Bx	By	C	D	E Minimum Opening	F Min.	G	H
G4M45E2	1/4	1/8	1.01	0.68	0.65	0.74	0.64	0.19	0.38	9/16	9/16
G4M45E4	1/4	1/4	1.01	0.68	0.83	0.74	0.64	0.19	0.56	9/16	9/16
G6M45E2	3/8	1/8	1.15	0.81	0.72	0.81	0.71	0.19	0.38	11/16	9/16
G6M45E4	3/8	1/4	1.15	0.81	0.90	0.81	0.71	0.28	0.56	11/16	9/16
G6M45E6	3/8	3/8	1.20	0.86	0.95	0.81	0.71	0.28	0.56	11/16	3/4
G8M45E6	1/2	3/8	1.33	0.86	0.95	0.93	0.97	0.38	0.56	7/8	3/4

Finger-tight assembly dimensions (shown in inches) are for reference only and subject to change.
 When ordering specify material designator with part number (see page 3 for complete ordering information).

Tube to Male Pipe

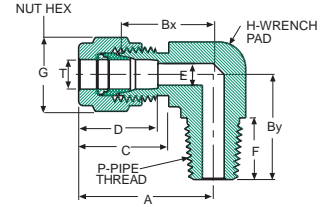

Male Elbow (ME)

Griplok Part #	T Tube O.D.	P-NPT Male Pipe Size	A	Bx	By	C	D	E Minimum Opening	F Min.	G
G1ME1	1/16	1/16	0.81	0.60	0.70	0.49	0.40	0.05	0.38	5/16
G1ME2	1/16	1/8	0.81	0.60	0.70	0.49	0.40	0.05	0.38	5/16
G2ME1	1/8	1/16	0.99	0.67	0.70	0.66	0.56	0.09	0.38	7/16
G2ME2	1/8	1/8	0.99	0.67	0.70	0.66	0.56	0.09	0.38	7/16
G2ME4	1/8	1/4	1.03	0.71	0.92	0.66	0.56	0.09	0.56	7/16
G3ME2	3/16	1/8	1.05	0.74	0.74	0.68	0.59	0.12	0.38	1/2
G3ME4	3/16	1/4	1.05	0.74	0.92	0.68	0.59	0.12	0.56	1/2
G4ME2	1/4	1/8	1.10	0.77	0.74	0.74	0.64	0.19	0.38	9/16
G4ME4	1/4	1/4	1.10	0.77	0.92	0.74	0.64	0.119	0.56	9/16
G4ME6	1/4	3/8	1.21	0.88	1.03	0.74	0.64	0.19	0.56	9/16
G4ME8	1/4	1/2	1.29	0.96	1.30	0.74	0.64	0.19	0.75	9/16
G5ME2	5/16	1/8	1.13	0.84	0.78	0.73	0.64	0.19	0.38	5/8
G5ME4	5/16	1/4	1.13	0.84	0.96	0.73	0.64	0.25	0.56	5/8
G5ME6	5/16	3/8	1.20	0.91	1.03	0.73	0.64	0.25	0.56	5/8
G6ME2	3/8	1/8	1.25	0.91	0.82	0.81	0.71	0.19	0.38	11/16
G6ME4	3/8	1/4	1.25	0.91	1.00	0.81	0.71	0.28	0.56	11/16
G6ME6	3/8	3/8	1.28	0.94	1.03	0.81	0.71	0.28	0.56	11/16
G6ME8	3/8	1/2	1.36	1.02	1.30	0.81	0.71	0.28	0.75	11/16
G6ME12	3/8	3/4	1.51	1.17	1.45	0.81	0.71	0.28	0.75	11/16
G8ME4	1/2	1/4	1.49	1.02	1.11	0.93	0.97	0.28	0.56	7/8
G8ME6	1/2	3/8	1.49	1.02	1.11	0.93	0.97	0.38	0.56	7/8
G8ME8	1/2	1/2	1.49	1.02	1.30	0.93	0.97	0.41	0.75	7/8
G8ME12	1/2	3/4	1.64	1.17	1.45	0.93	0.97	0.41	0.75	7/8
G10ME6	5/8	3/8	1.54	1.10	1.19	0.90	1.00	0.38	0.56	1
G10ME8	5/8	1/2	1.54	1.10	1.38	0.90	1.00	0.47	0.75	1
G10ME12	5/8	3/4	1.61	1.17	1.45	0.90	1.00	0.50	0.56	1
G12ME8	3/4	1/2	1.61	1.17	1.45	0.90	1.00	0.47	0.75	1-1/8
G12ME12	3/4	3/4	1.61	1.17	1.45	0.90	1.00	0.62	0.75	1-1/8
G14ME12	7/8	3/4	1.80	1.36	1.64	0.90	1.06	0.62	0.75	1-1/4
G16ME12	1	3/4	2.01	1.45	1.64	1.12	1.31	0.62	0.75	1-1/2
G16ME16	1	1	2.01	1.45	1.83	1.12	1.31	0.88	0.75	1-1/2

Finger-tight assembly dimensions (shown in inches) are for reference only and subject to change.
 When ordering specify material designator with part number (see page 3 for complete ordering information).

Fractional Tube to ISO Thread Fittings

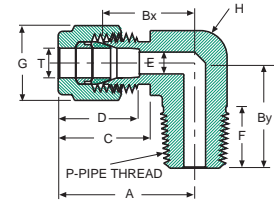

Male Elbow - ISO Tapered (MERT)

Griplok Part#	T Tube O.D.	P ISO Male Pipe	A	F	C	D	E Min. Opening	H Wrench Pad	G Hex Flat	Bx	By
G2MERT2	1/8	1/8	0.93	0.38	0.60	0.50	0.09	7/16	7/16	0.67	0.70
G4MERT2	1/4	1/8	1.06	0.38	0.70	0.60	0.19	1/2	9/16	0.77	0.74
G4MERT4	1/4	1/4	1.06	0.56	0.70	0.60	0.19	1/2	9/16	0.77	0.92
G4MERT6	1/4	3/8	1.17	0.56	0.70	0.60	0.19	11/16	9/16	0.88	1.03
G4MERT8	1/4	1/2	1.25	0.75	0.70	0.60	0.19	13/16	9/16	0.96	1.30
G5MERT4	5/16	1/4	1.13	0.56	0.73	0.64	0.25	9/16	5/8	0.84	0.96
G6MERT2	3/8	1/8	1.20	0.38	0.76	0.66	0.19	5/8	11/16	0.91	0.82
G6MERT4	3/8	1/4	1.20	0.56	0.76	0.66	0.28	5/8	11/16	0.91	1.00
G6MERT6	3/8	3/8	1.23	0.56	0.76	0.66	0.28	11/16	11/16	0.94	1.03
G6MERT8	3/8	1/2	1.31	0.75	0.76	0.66	0.28	13/16	11/16	1.02	1.30
G8MERT4	1/2	1/4	1.42	0.56	0.86	0.90	0.28	13/16	7/8	1.02	1.11
G8MERT6	1/2	3/8	1.42	0.56	0.86	0.90	0.38	13/16	7/8	1.02	1.11
G8MERT8	1/2	1/2	1.42	0.75	0.86	0.90	0.41	13/16	7/8	1.02	1.30

NOTE: RT threaded fittings conform to ISO (International Standards Organization) standards 7/1.

Tube to Male Pipe

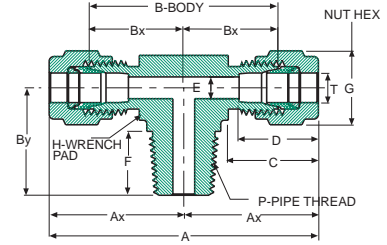

Male Branch Tee (MBT)

Griplik Part #	T Tube O.D.	P-NPT Male Pipe Size	A	Ax	B	Bx	By	C	D	E Minimum Opening	F Min.	G	H
G2MBT2	1/8	1/8	1.92	0.93	1.34	0.67	0.70	0.66	0.56	0.09	0.38	7/16	5/16
G2MBT4	1/8	1/4	2.00	0.97	1.42	0.71	0.92	0.66	0.56	0.09	0.56	7/16	9/16
G3MBT2	3/16	1/8	1.97	0.96	1.40	0.70	0.70	0.68	0.59	0.12	0.38	1/2	7/16
G4MBT2	1/4	1/8	2.16	1.06	1.54	0.77	0.74	0.74	0.64	0.19	0.38	9/16	1/2
G4MBT4	1/4	1/4	2.16	1.06	1.54	0.77	0.92	0.74	0.64	0.19	0.56	9/16	9/16
G5MBT2	5/16	1/8	2.34	1.17	1.76	0.88	0.82	0.73	0.64	0.19	0.38	5/8	5/8
G6MBT4	3/8	1/4	2.45	1.20	1.82	0.91	1.00	0.81	0.71	0.28	0.56	11/16	5/8
G6MBT6	3/8	3/8	2.67	1.31	2.04	1.02	1.11	0.81	0.71	0.28	0.56	11/16	13/16
G8MBT6	1/2	3/8	2.91	1.42	2.04	1.02	1.11	0.93	0.97	0.38	0.56	7/8	13/16
G8MBT8	1/2	1/2	2.91	1.42	2.04	1.02	1.30	0.93	0.97	0.41	0.75	7/8	7/8
G10MBT8	5/8	1/2	3.10	1.53	2.26	1.13	1.41	0.90	1.00	0.47	0.75	1	1
G12MBT12	3/4	3/4	3.18	1.57	2.34	1.17	1.45	0.90	1.00	0.62	0.75	1-1/8	1-1/16

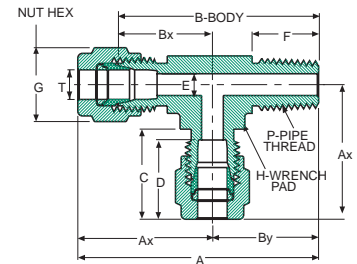
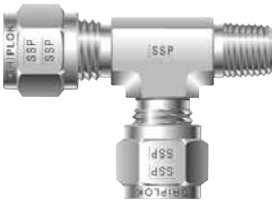

Male Run Tee (MRT)

Griplik Part #	T Tube O.D.	P-NPT Male Pipe Size	A	Ax	B	Bx	By	C	D	E Minimum Opening	F Min.	G	H
G2MRT2	1/8	1/8	1.69	0.93	1.37	0.67	0.70	0.66	0.56	0.09	0.38	7/16	5/16
G2MRT4	1/8	1/4	1.95	0.97	1.63	0.71	0.92	0.66	0.56	0.09	0.56	7/16	9/16
G3MRT2	3/16	1/8	1.71	0.96	1.40	0.70	0.70	0.68	0.59	0.12	0.38	1/2	7/16
G4MRT2	1/4	1/8	1.84	1.06	1.51	0.77	0.74	0.74	0.64	0.19	0.38	9/16	1/2
G4MRT4	1/4	1/4	2.02	1.06	1.69	0.77	0.92	0.74	0.64	0.19	0.56	9/16	9/16
G5MRT2	5/16	1/8	1.99	1.17	1.70	0.88	0.82	0.73	0.64	0.19	0.38	5/8	5/8
G6MRT4	3/8	1/4	2.25	1.20	1.91	0.91	1.00	0.81	0.71	0.28	0.56	11/16	5/8
G6MRT6	3/8	3/8	2.47	1.31	2.13	1.02	1.11	0.81	0.71	0.28	0.56	11/16	13/16
G8MRT6	1/2	3/8	2.60	1.42	2.13	1.02	1.11	0.93	0.97	0.38	0.56	7/8	13/16
G8MRT8	1/2	1/2	2.79	1.42	2.32	1.02	1.30	0.93	0.97	0.41	0.75	7/8	7/8
G10MRT8	5/8	1/2	2.92	1.50	2.48	1.10	1.38	0.90	1.00	0.47	0.75	1	1
G12MRT12	3/4	3/4	3.06	1.57	2.62	1.17	1.45	0.90	1.00	0.62	0.75	1-1/8	1-1/16

Finger-tight assembly dimensions (shown in inches) are for reference only and subject to change.

When ordering specify material designator with part number (see page 3 for complete ordering information).

Tube to Female Pipe

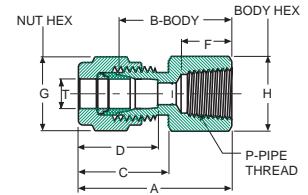

Female Connector (FC)

Griplok Part #	T Tube O.D.	P-NPT Female Pipe Size	A	B	C	D	E Minimum Opening	F	G	H
G1FC1	1/16	1/16	0.99	0.78	0.49	0.40	0.05	0.39	5/16	7/16
G1FC2	1/16	1/8	1.02	0.81	0.49	0.40	0.05	0.41	5/16	9/16
G2FC2	1/8	1/8	1.19	0.87	0.66	0.56	0.09	0.41	7/16	9/16
G2FC4	1/8	1/4	1.38	1.06	0.66	0.56	0.09	0.59	7/16	3/4
G3FC2	3/16	1/8	1.22	0.91	0.68	0.59	0.12	0.39	1/2	9/16
G4FC2	1/4	1/8	1.27	0.94	0.74	0.64	0.19	0.39	9/16	9/16
G4FC4	1/4	1/4	1.45	1.12	0.74	0.64	0.19	0.59	9/16	3/4
G4FC6	1/4	3/8	1.52	1.19	0.74	0.64	0.19	0.59	9/16	7/8
G4FC8	1/4	1/2	1.71	1.38	0.74	0.64	0.19	0.78	9/16	1-1/16
G5FC2	5/16	1/8	1.26	0.97	0.73	0.64	0.25	0.39	5/8	9/16
G5FC4	5/16	1/4	1.45	1.16	0.73	0.64	0.25	0.59	5/8	3/4
G6FC2	3/8	1/8	1.34	1.00	0.81	0.71	0.28	0.39	11/16	5/8
G6FC4	3/8	1/4	1.53	1.19	0.81	0.71	0.28	0.59	11/16	3/4
G6FC6	3/8	3/8	1.59	1.25	0.81	0.71	0.28	0.59	11/16	7/8
G6FC8	3/8	1/2	1.78	1.44	0.81	0.71	0.28	0.78	11/16	1-1/16
G6FC12	3/8	3/4	1.93	1.59	0.81	0.71	0.28	0.81	11/16	1-5/16
G8FC4	1/2	1/4	1.66	1.19	0.93	0.97	0.41	0.59	7/8	13/16
G8FC6	1/2	3/8	1.72	1.25	0.93	0.97	0.41	0.59	7/8	7/8
G8FC8	1/2	1/2	1.91	1.44	0.93	0.97	0.41	0.78	7/8	1-1/16
G8FC12	1/2	3/4	1.97	1.50	0.93	0.97	0.41	0.81	7/8	1-5/16
G10FC6	5/8	3/8	1.69	1.25	0.90	1.00	0.50	0.59	1	1-5/16
G10FC8	5/8	1/2	1.88	1.44	0.90	1.00	0.50	0.78	1	1-1/16
G12FC8	3/4	1/2	1.88	1.44	0.90	1.00	0.62	0.78	1-1/8	1-1/16
G12FC12	3/4	3/4	1.94	1.50	0.90	1.00	0.62	0.81	1-1/8	1-5/16
G14FC12	7/8	3/4	2.00	1.56	0.90	1.06	0.72	0.81	1-1/4	1-5/16
G16FC12	1	3/4	2.18	1.62	1.12	1.31	0.88	0.81	1-1/2	1-3/8
G16FC16	1	1	2.53	1.97	1.12	1.31	0.88	1.00	1-1/2	1-5/8

Finger-tight assembly dimensions (shown in inches) are for reference only and subject to change.
 When ordering specify material designator with part number (see page 3 for complete ordering information).

Tube to Female Pipe

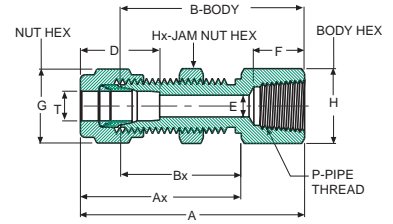
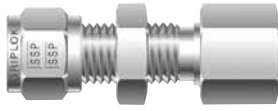

Bulkhead Female Connector (BFC)

Griplik Part #	T Tube O.D.	P-NPT Female Pipe Size	A	Ax	B	Bx	D	E Minimum Opening	F	G	H	Hx	Maximum Panel Thickness	Panel Hole Drill Size
G2BFC2	1/8	1/8	1.82	1.23	1.50	0.97	0.56	0.09	0.41	7/16	9/16	1/2	0.50	21/64
G4BFC2	1/4	1/8	1.89	1.32	1.56	1.03	0.64	0.19	0.41	9/16	5/8	5/8	0.40	29/64
G4BFC4	1/4	1/4	2.08	1.32	1.75	1.03	0.64	0.19	0.59	9/16	3/4	5/8	0.40	49/64
G6BFC4	3/8	1/4	2.22	1.45	1.88	1.16	0.71	0.28	0.59	11/16	3/4	3/4	0.44	37/64
G8BFC6	1/2	3/8	2.50	1.65	2.03	1.25	0.97	0.41	0.59	7/8	15/16	15/16	0.50	49/64
G8BFC8	1/2	1/2	2.69	1.65	2.22	1.25	0.97	0.41	0.78	7/8	1-1/16	15/16	0.50	49/64

Finger-tight assembly dimensions (shown in inches) are for reference only and subject to change.
 When ordering specify material designator with part number (see page 3 for complete ordering information).

Tube to Female Pipe

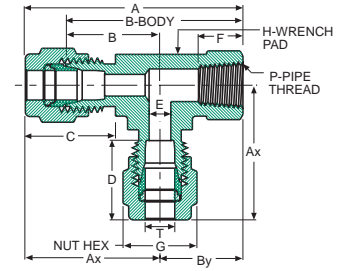
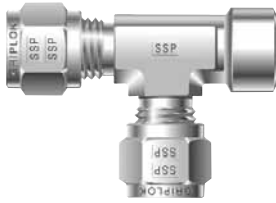

Female Run Tee (FRT)

Griplok Part #	T Tube O.D.	P-NPT Female Pipe Size	A	Ax	B	Bx	By	C	D	E Minimum Opening	F	G	H
G2FRT2	1/8	1/8	1.78	0.97	1.46	0.71	0.75	0.66	0.56	0.09	0.41	7/16	9/16
G4FRT2	1/4	1/8	1.85	1.06	1.52	0.77	0.75	0.74	0.64	0.19	0.41	9/16	9/16
G4FRT4	1/4	1/4	2.09	1.17	1.76	0.88	0.88	0.74	0.64	0.19	0.59	9/16	3/4
G6FRT4	3/8	1/4	2.16	1.23	1.82	0.94	0.88	0.81	0.71	0.28	0.59	11/16	3/4
G8FRT6	1/2	3/8	2.37	1.42	1.90	1.02	0.88	0.93	0.97	0.41	0.59	7/8	7/8
G8FRT8	1/2	1/2	2.76	1.57	2.29	1.17	1.12	0.93	0.97	0.41	0.78	7/8	1-1/16
G12FRT12	3/4	3/4	3.05	1.76	2.61	1.36	1.25	0.90	1.00	0.62	0.81	1-1/8	1-3/8

Finger-tight assembly dimensions (shown in inches) are for reference only and subject to change.
 When ordering specify material designator with part number (see page 3 for complete ordering information).

Tube to Female Pipe

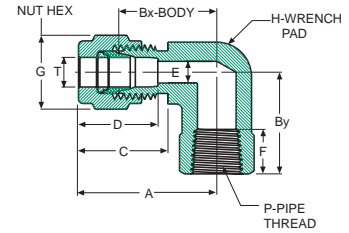

Female Elbow (FE)

Griplok Part #	T Tube O.D.	P-NPT Female Pipe Size	A	Bx	By	C	D	E Minimum Opening	F	G	H
G2FE2	1/8	1/8	1.03	0.71	0.75	0.66	0.56	0.09	0.41	7/16	1/2
G2FE4	1/8	1/4	1.14	0.82	0.88	0.66	0.56	0.09	0.59	7/16	3/4
G3FE2	3/16	1/8	1.05	0.74	0.75	0.68	0.59	0.12	0.39	1/2	1/2
G4FE2	1/4	1/8	1.10	0.77	0.75	0.74	0.64	0.19	0.39	9/16	1/2
G4FE4	1/4	1/4	1.21	0.88	0.88	0.74	0.64	0.19	0.59	9/16	3/4
G4FE6	1/4	3/8	1.29	0.96	0.88	0.74	0.64	0.19	0.59	9/16	7/8
G4FE8	1/4	1/2	1.40	1.07	1.12	0.74	0.64	0.19	0.78	9/16	1
G5FE2	5/16	1/8	1.13	0.84	0.75	0.73	0.64	0.25	0.39	5/8	9/16
G5FE4	5/16	1/4	1.20	0.91	0.88	0.73	0.64	0.25	0.59	5/8	3/4
G6FE2	3/8	1/8	1.25	0.91	0.75	0.81	0.71	0.28	0.39	11/16	5/8
G6FE4	3/8	1/4	1.28	0.94	0.88	0.81	0.71	0.28	0.59	11/16	3/4
G6FE6	3/8	3/8	1.36	1.02	0.88	0.81	0.71	0.28	0.59	11/16	7/8
G6FE8	3/8	1/2	1.47	1.13	1.12	0.81	0.71	0.28	0.78	11/16	1
G8FE4	1/2	1/4	1.49	1.02	0.88	0.93	0.97	0.41	0.59	7/8	13/16
G8FE6	1/2	3/8	1.49	1.02	0.88	0.93	0.97	0.41	0.59	7/8	7/8
G8FE8	1/2	1/2	1.60	1.13	1.12	0.93	0.97	0.41	0.78	7/8	1
G10FE6	5/8	3/8	1.54	1.10	0.88	0.90	1.00	0.50	0.59	1	15/16
G10FE8	5/8	1/2	1.61	1.17	1.12	0.90	1.00	0.50	0.78	1	1-1/16
G12FE8	3/4	1/2	1.61	1.17	1.12	0.90	1.00	0.62	0.78	1-1/8	1-1/16
G12FE12	3/4	3/4	1.80	1.36	1.25	0.90	1.00	0.62	0.81	1-1/8	1-3/8
G14FE12	7/8	3/4	1.80	1.36	1.25	0.90	1.06	0.72	0.81	1-1/4	1-3/8
G16FE12	1	3/4	2.01	1.45	1.25	1.12	1.31	0.88	0.81	1-1/2	1-3/8
G16FE16	1	1	2.19	1.63	1.50	1.12	1.31	0.88	1.00	1-1/2	1-5/8

Finger-tight assembly dimensions (shown in inches) are for reference only and subject to change.
 When ordering specify material designator with part number (see page 3 for complete ordering information).

Tube to Female Pipe/Tube to Tube Union

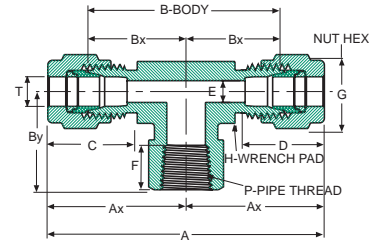

Female Branch Tee (FBT)

Griplok Part #	T Tube O.D.	P-NPT Female Pipe Size	A	Ax	B	Bx	By	C	D	E Minimum Opening	F	G	H
G2FBT2	1/8	1/8	2.00	0.97	1.42	0.71	0.75	0.66	0.56	0.09	0.41	7/16	9/16
G4FBT2	1/4	1/8	2.16	1.06	1.54	0.77	0.75	0.74	0.64	0.19	0.41	9/16	9/16
G4FBT4	1/4	1/4	2.38	1.17	1.76	0.88	0.88	0.74	0.64	0.19	0.59	9/16	3/4
G6FBT4	3/8	1/4	2.51	1.23	1.88	0.94	0.88	0.81	0.71	0.28	0.59	11/16	3/4
G8FBT4	1/2	1/4	2.91	1.42	2.04	1.02	0.88	0.93	0.97	0.41	0.59	7/8	13/16
G8FBT6	1/2	3/8	2.91	1.42	2.04	1.02	0.88	0.93	0.97	0.41	0.59	7/8	7/8
G8FBT8	1/2	1/2	3.13	1.53	2.26	1.13	1.12	0.93	0.97	0.41	0.78	7/8	1
G10FBT8	5/8	1/2	3.10	1.53	2.26	1.13	1.12	0.90	1.00	0.50	0.78	1	1
G12FBT12	3/4	3/4	3.56	1.76	2.72	1.36	1.25	0.90	1.00	0.62	0.81	1-1/8	1-3/8
G16FBT12	1	3/4	3.94	1.93	2.90	1.45	1.25	1.12	1.31	0.88	0.81	1-1/2	1-3/8
G16FBT16	1	1	4.30	2.11	3.26	1.63	1.50	1.12	1.31	0.88	1.00	1-1/2	1-5/8

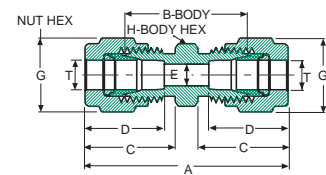

Union (U)

Griplok Part #	T Tube O.D.	A	B	C	D	E Minimum Opening	G	H
G1U	1/16	1.05	0.69	0.49	0.40	0.05	5/16	5/16
G2U	1/8	1.46	0.88	0.66	0.56	0.09	7/16	7/16
G3U	3/16	1.52	0.95	0.68	0.59	0.12	1/2	7/16
G4U	1/4	1.65	1.03	0.74	0.64	0.19	9/16	1/2
G5U	5/16	1.69	1.11	0.73	0.64	0.25	5/8	9/16
G6U	3/8	1.82	1.19	0.81	0.71	0.28	11/16	5/8
G8U	1/2	2.09	1.22	0.93	0.97	0.41	7/8	13/16
G10U	5/8	2.09	1.25	0.90	1.00	0.50	1	15/16
G12U	3/4	2.15	1.31	0.90	1.00	0.62	1-1/8	1-1/16
G14U	7/8	2.21	1.37	0.90	1.06	0.72	1-1/4	1-3/16
G16U	1	2.63	1.59	1.12	1.31	0.88	1-1/2	1-3/8

Finger-tight assembly dimensions (shown in inches) are for reference only and subject to change.
 When ordering specify material designator with part number (see page 3 for complete ordering information).

Tube to Tube Union

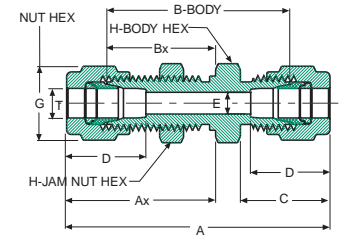

Bulkhead Union (BU)

Griplok Part #	T Tube O.D.	A	Ax	B	Bx	C	D	E Minimum Opening	G	H	Maximum Panel Thickness	Panel Hole Drill Size
G1BU	1/16	1.30	0.68	0.94	0.53	0.49	0.40	0.05	5/16	5/16	0.12	13/16
G2BU	1/8	2.08	1.23	1.50	0.97	0.66	0.56	0.09	7/16	1/2	0.50	21/64
G3BU	3/16	2.16	1.26	1.59	1.00	0.68	0.59	0.12	1/2	9/16	0.50	25/64
G4BU	1/4	2.31	1.32	1.69	1.03	0.74	0.64	0.19	9/16	5/8	0.40	49/64
G5BU	5/16	2.39	1.41	1.81	1.12	0.73	0.64	0.25	5/8	11/16	0.44	33/64
G6BU	3/8	2.50	1.45	1.87	1.16	0.81	0.71	0.28	11/16	3/4	0.44	37/64
G8BU	1/2	2.87	1.65	2.00	1.25	0.93	0.97	0.41	7/8	15/16	0.50	49/64
G10BU	5/8	2.90	1.68	2.06	1.28	0.90	1.00	0.50	1	1-1/16	0.50	57/64
G12BU	3/4	3.15	1.87	2.31	1.47	0.90	1.00	0.63	1-1/8	1-3/16	0.66	1-1/64
G16BU	1	3.85	2.26	2.81	1.78	1.12	1.31	0.88	1-1/2	1-5/8	0.75	1-21/64

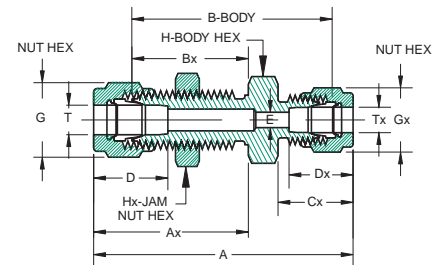

Bulkhead Reducing Union (BRU)

Griplok Part #	T Tube O.D.	Tx Tube O.D.	A	Ax	B	Bx	Cx	D	Dx	E Minimum Opening	G	Gx	H	Hx	Maximum Panel Thickness	Panel Hole Drill Size
G4BRU2	1/4	1/8	2.21	1.36	1.62	1.03	0.60	0.64	0.50	0.09	9/16	7/16	5/8	55/8	0.40	29/64
G6BRU4	3/8	1/4	2.44	1.49	1.81	1.16	0.70	0.71	0.60	0.19	11/16	9/16	3/4	3/4	0.44	37/64
G8BRU4	1/2	1/4	2.70	1.72	1.94	1.25	0.70	0.97	0.60	0.19	7/8	9/16	15/16	15/16	0.50	49/64
G8BRU6	1/2	3/8	2.75	1.72	1.99	1.25	0.75	0.97	0.66	0.19	7/8	11/16	15/16	15/16	0.50	49/64

Finger-tight assembly dimensions (shown in inches) are for reference only and subject to change.
 When ordering specify material designator with part number (see page 3 for complete ordering information).

Tube to Tube Union

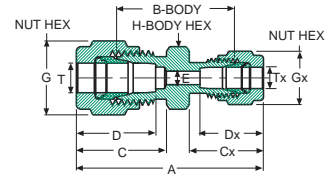
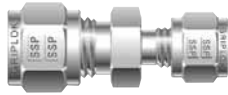

Reducing Union (RU)

Griplok Part #	T Tube O.D.	Tx Tube O.D.	A	B	C	Cx	D	Dx	E Minimum Opening	G	Gx	H
G2RU1	1/8	1/16	1.28	0.81	0.66	0.43	0.56	0.34	0.05	7/16	5/16	7/16
G3RU1	3/16	1/16	1.32	0.86	0.68	0.43	0.59	0.34	0.05	1/2	5/16	7/16
G3RU2	3/16	1/8	1.49	0.92	0.68	0.60	0.59	0.50	0.09	1/2	7/16	7/16
G4RU1	1/4	1/16	1.39	0.91	0.74	0.43	0.64	0.34	0.05	9/16	5/16	1/2
G4RU2	1/4	1/8	1.56	0.97	0.74	0.60	0.64	0.50	0.09	9/16	7/16	1/2
G4RU3	1/4	3/16	1.59	1.00	0.74	0.63	0.64	0.54	0.12	9/16	1/2	1/2
G5RU2	5/16	1/8	1.57	1.02	0.73	0.60	0.64	0.50	0.09	5/8	7/16	9/16
G5RU4	5/16	1/4	1.66	1.08	0.73	0.70	0.64	0.60	0.19	5/8	9/16	9/16
G6RU1	3/8	1/16	1.49	1.00	0.81	0.43	0.71	0.34	0.05	11/16	5/16	5/8
G6RU2	3/8	1/8	1.63	1.06	0.81	0.60	0.71	0.50	0.09	11/16	7/16	5/8
G6RU4	3/8	1/4	1.75	1.12	0.81	0.70	0.71	0.60	0.19	11/16	9/16	5/8
G6RU5	3/8	5/16	1.79	1.16	0.81	0.73	0.71	0.64	0.25	11/16	5/8	5/8
G8RU2	1/2	1/8	1.85	1.12	0.93	0.60	0.97	0.50	0.09	7/8	7/16	13/16
G8RU4	1/2	1/4	1.92	1.16	0.93	0.70	0.97	0.60	0.19	7/8	9/16	13/16
G8RU6	1/2	3/8	1.98	1.22	0.93	0.76	0.97	0.66	0.28	7/8	11/16	13/16
G10RU6	5/8	3/8	1.98	1.25	0.90	0.76	1.00	0.66	0.28	1	11/16	15/16
G10RU8	5/8	1/2	2.09	1.25	0.90	0.86	1.00	0.90	0.41	1	7/8	15/16
G12RU4	3/4	1/4	1.98	1.25	0.90	0.70	1.00	0.60	0.19	1-1/8	9/16	1-1/16
G12RU6	3/4	3/8	2.04	1.31	0.90	0.76	1.00	0.66	0.28	1-1/8	11/16	1-1/16
G12RU8	3/4	1/2	2.15	1.31	0.90	0.86	1.00	0.90	0.41	1-1/8	7/8	1-1/16
G12RU10	3/4	5/8	2.15	1.31	0.90	0.86	1.00	0.96	0.50	1-1/8	1	1-1/16
G16RU8	1	1/2	2.57	1.61	1.12	0.86	1.31	0.90	0.41	1-1/2	7/8	1-3/8
G16RU12	1	3/4	2.55	1.59	1.12	0.86	1.31	0.96	0.62	1-1/2	1-1/8	1-3/8

Finger-tight assembly dimensions (shown in inches) are for reference only and subject to change.

When ordering specify material designator with part number (see page 3 for complete ordering information).

Tube to Tube Union

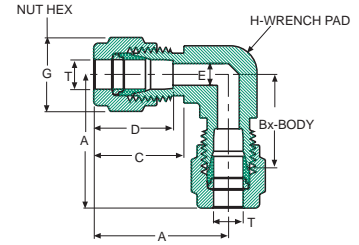

Union Elbow (UE)

Griplik Part #	T Tube O.D.	A	Bx	C	D	E Minimum Opening	F	G	H
G1UE	1/16	0.76	0.55	0.49	0.40	0.05	3/8	5/16	3/8
G2UE	1/8	0.94	0.62	0.66	0.56	0.09	3/8	7/16	3/8
G3UE	3/16	1.05	0.74	0.68	0.59	0.12	1/2	1/2	1/2
G4UE	1/4	1.10	0.77	0.74	0.64	0.19	1/2	9/16	1/2
G5UE	5/16	1.13	0.84	0.73	0.64	0.25	9/16	5/8	9/16
G6UE	3/8	1.25	0.91	0.81	0.71	0.28	5/8	11/16	5/8
G8UE	1/2	1.49	1.02	0.93	0.97	0.41	13/16	7/8	13/16
G10UE	5/8	1.54	1.10	0.90	1.00	0.50	15/16	1	15/16
G12UE	3/4	1.61	1.17	0.90	1.00	0.62	1-1/16	1-1/8	1-1/16
G14UE	7/8	1.80	1.36	0.90	1.06	0.72	1-3/8	1-1/4	1-3/8
G16UE	1	2.01	1.45	1.12	1.31	0.88	1-3/8	1-1/2	1-3/8

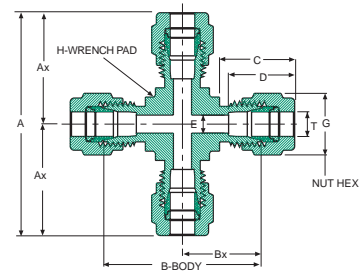
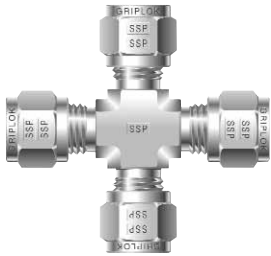

Union Cross (UCS)

Griplik Part #	T Tube O.D.	A	Ax	B	Bx	C	D	E Minimum Opening	G	H
G2UCS	1/8	1.82	0.88	1.24	0.62	0.66	0.56	0.09	7/16	7/16
G4UCS	1/4	2.16	1.06	1.54	0.77	0.74	0.64	0.19	9/16	7/16
G5UCS	5/16	2.34	1.17	1.76	0.88	0.73	0.64	0.25	5/8	9/16
G6UCS	3/8	2.45	1.20	1.82	0.91	0.81	0.71	0.28	11/16	9/16
G8UCS	1/2	2.91	1.42	2.04	1.02	0.93	0.97	0.41	7/8	3/4
G12UCS	3/4	3.18	1.57	2.34	1.17	0.90	1.00	0.62	1-1/8	1-1/16

Finger-tight assembly dimensions (shown in inches) are for reference only and subject to change.
 When ordering specify material designator with part number (see page 3 for complete ordering information).

Tube to Tube Union

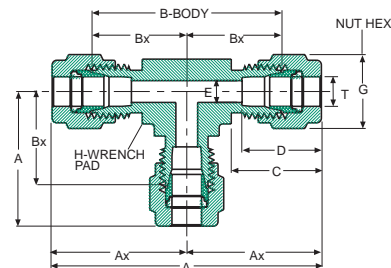
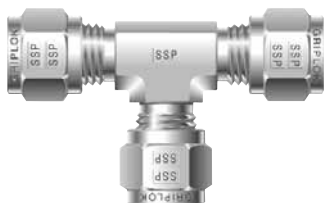

Union Tee (UT)

Griplik Part #	T Tube O.D.	A	Ax	B	Bx	C	D	E Minimum Opening	G	H
G1UT	1/16	1.46	0.70	1.10	0.55	0.49	0.40	0.05	5/16	3/8
G2UT	1/8	1.82	0.88	1.24	0.62	0.66	0.56	0.09	7/16	3/8
G3UT	3/16	1.97	0.96	1.40	0.70	0.68	0.59	0.12	1/2	7/16
G4UT	1/4	2.16	1.06	1.54	0.77	0.74	0.64	0.19	9/16	1/2
G5UT	5/16	2.34	1.17	1.76	0.88	0.73	0.64	0.25	5/8	5/8
G6UT	3/8	2.45	1.20	1.82	0.91	0.81	0.71	0.28	11/16	5/8
G8UT	1/2	2.91	1.42	2.04	1.02	0.93	0.97	0.41	7/8	13/16
G10UT	5/8	3.10	1.53	2.26	1.13	0.90	1.00	0.50	1	1
G12UT	3/4	3.18	1.57	2.34	1.17	0.90	1.00	0.62	1-1/8	1-1/16
G14UT	7/8	3.56	1.76	2.72	1.36	0.90	1.06	0.72	1-1/4	1-3/8
G16UT	1	3.94	1.93	2.90	1.45	1.12	1.31	0.88	1-1/2	1-3/8

Heat Exchanger Tee

Custom configuration, forged heat exchanger tees can be designed and manufactured by SSP to customers' specific design criteria. Additionally, heat exchanger tees may be assembled by utilizing standard union tees (UT) combined with reducers that have been "bored through" (RBT fittings) to allow the process tube to be inserted into and through the jacketing tube.

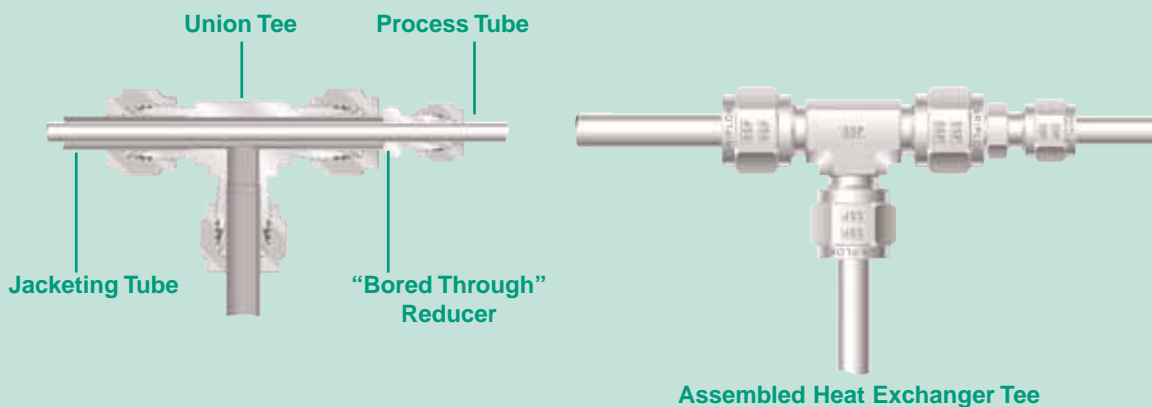

NOTE: Pressure Ratings of "bored through" tube fittings are reduced. For additional information on a specific fitting's rating, contact your local distributor.

Tube to Tube Union

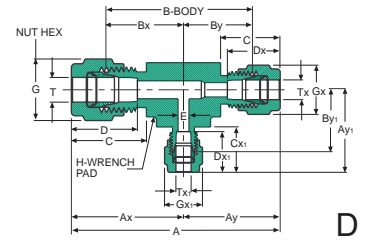
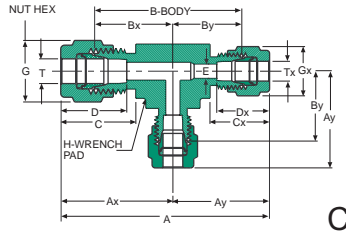
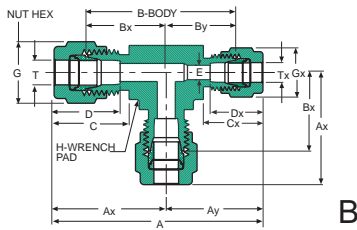
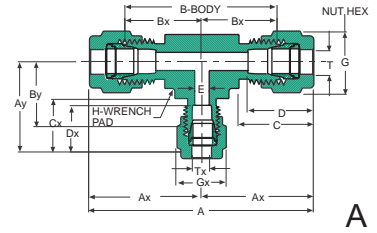

Reducing Union Tee - Configuration A (RUT)

Griplok Part #	T Tube O.D.	Tx Tube O.D.	A	Ax	Ay	B	Bx	By	C	Cx	D	Dx	E	G	Gx	H
G6RUT64	3/8	1/4	2.45	1.25	1.19	1.82	0.91	0.85	0.81	0.75	0.71	0.65	0.19	11/16	9/16	5/8
G8RUT84	1/2	1/4	2.91	1.49	1.32	2.04	1.02	.96	0.91	0.77	0.97	0.67	0.19	7/8	9/16	13/16
G8RUT86	1/2	3/8	2.91	1.49	1.38	2.04	1.02	1.02	0.91	0.83	0.97	0.73	0.28	7/8	11/16	13/16
G10RUT106	5/8	3/8	3.10	1.57	1.46	2.26	1.13	1.13	0.90	0.80	1.00	0.70	0.28	1	11/16	1
G12RUT126	3/4	3/8	3.18	1.61	1.50	2.34	1.17	1.17	0.90	0.80	1.00	0.70	0.28	1-1/8	11/16	1-1/16
G12RUT128	3/4	1/2	3.18	1.61	1.61	2.34	1.17	1.17	0.90	0.90	1.00	0.94	0.41	1-1/8	7/8	1-1/16
G16RUT166	1	3/8	3.94	2.01	1.73	2.90	1.45	1.36	1.12	0.84	1.31	0.74	0.28	1-1/2	1-1/16	1-3/8
G16RUT168	1	1/2	3.94	2.01	1.84	2.90	1.45	1.36	1.12	0.98	1.31	0.94	0.41	1-1/2	7/8	1-3/8
G16RUT1612	1	3/4	3.94	2.01	1.84	2.90	1.45	1.36	1.12	0.94	1.31	1.04	0.62	1-1/2	1-1/8	1-3/8

Reducing Union Tee - Configuration B (RUT)

Griplok Part #	T Tube O.D.	Tx Tube O.D.	A	Ax	Ay	B	Bx	By	C	Cx	D	Dx	E	G	Gx	H
G6RUT46	3/8	1/4	2.39	1.25	1.19	1.76	0.91	0.85	0.81	0.75	0.71	0.65	0.19	11/16	9/16	5/8

Reducing Union Tee - Configuration C (RUT)

Griplok Part #	T Tube O.D.	Tx Tube O.D.	A	Ax	Ay	B	Bx	By	C	Cx	D	Dx	E	G	Gx	H
G8RUT66	1/2	3/8	3.00	1.49	1.38	2.04	1.02	1.02	0.93	0.83	0.97	0.73	0.28	7/8	11/16	13/16
G10RUT66	5/8	3/8	2.99	1.57	1.46	2.26	1.13	1.13	0.90	0.80	1.00	0.70	0.28	1	11/16	1
G12RUT66	3/4	3/8	3.07	1.61	1.50	2.34	1.17	1.17	0.90	0.80	1.00	0.70	0.28	1-1/8	11/16	1-1/16

Reducing Union Tee - Configuration D (RUT)

Griplok Part #	T Tube O.D.	Tx Tube O.D.	Tx1 Tube O.D.	A	Ax	Ay	Ay1	B	Bx	By	C	Cx	Cx1	D	Dx	Dx1	E	G	Gx	Gx1	H
G10RUT86	5/8	1/2	3/8	3.10	1.57	1.57	1.46	2.26	1.13	1.13	0.90	0.90	0.80	1.00	0.94	0.70	0.28	1	7/8	11/16	1
G12RUT86	3/4	1/2	3/8	3.18	1.61	1.61	1.50	2.34	1.17	1.17	0.90	0.90	0.80	1.00	0.94	0.70	0.28	1-1/16	7/8	11/16	1-1/16
G16RUT126	1	3/4	3/8	3.77	2.01	1.84	1.74	2.81	1.45	1.36	1.12	0.94	0.84	1.41	1.04	0.74	0.28	1-3/8	1-1/8	11/16	1-3/8

Finger-tight assembly dimensions (shown in inches) are for reference only and subject to change.
 When ordering specify material designator with part number (see page 3 for complete ordering information).

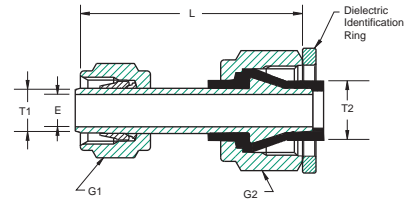

Dielectric Adapter (DA)

Griplik Part #	T1 Tube End	T2 Tube End	L	E	G1 Hex	G2 Hex
D8DA6	3/8	1/2	2.08	0.30	11/16	7/8

The SSP Instrumentation Dielectric Adapter is supplied with pre-swaged 3/8" Duolok nut and ferrules. The dielectric connection has a captive 1/2" Duolok nut. Dielectric stop collar and assembly instructions are also supplied with the adapter. By using 3/8" and 1/2" tube-ended SSP Instrumentation tube fittings with the adapter, a wide range of dielectric fitting configurations can be built.

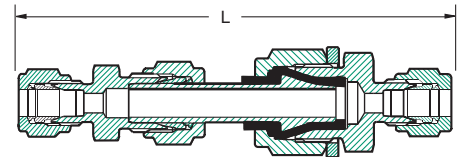

Dielectric Union (DU)

Griplik Part #	L (inches)
G4DU	4.08
G6DU	4.20
G8DU	4.79
G6DMC4	3.80

Dielectric fittings are designed to isolate monitoring and control instruments and equipment from electrical current and voltages. Manufactured in 316 stainless steel with thermoplastic insulators, SSP instrumentation's dielectric fittings provide high dielectric strength in applications up to 5,000 psig. Typical applications for dielectric fittings are on impulse lines and in natural gas pipeline monitoring stations. For additional factory assembled configurations, contact your local distributor.

Materials and Technical Data

Body: 316 Stainless Steel

Insulator: Polyamide-imide

Pressure Rating: 5,000 psig

Temperature Rating: From -40°F to +200°F

Electrical Resistance: 1.0 x 10E7 Ohm at 70°F (20°C) at 10 VDC @ 50% relative humidity; voltage breakdown resistance of 3,000 VDC.

Finger-tight assembly dimensions (shown in inches) are for reference only and subject to change.

When ordering specify material designator with part number (see page 3 for complete ordering information).

Tube to Welded System

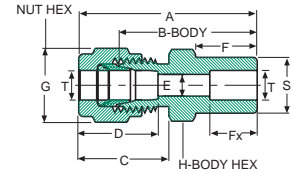

Tube Socket Weld Union (TSWU)

Griplok Part #	T Tube O.D.	A	B	C	D	E Minimum Opening	F	Fx	G	H	S
G2TSWU2	1/8	1.20	0.88	0.66	0.56	0.09	0.34	0.16	7/16	7/16	0.31
G4TSWU4	1/4	1.36	1.03	0.74	0.64	0.19	0.41	0.25	9/16	1/2	0.44
G6TSWU6	3/8	1.53	1.19	0.81	0.71	0.28	0.47	0.34	11/16	5/8	0.62
G8TSWU8	1/2	1.69	1.22	0.93	0.97	0.41	0.47	0.41	7/8	13/16	0.75
G12TSWU12	3/4	1.75	1.31	0.90	1.00	0.62	0.47	0.50	1-1/8	1-1/16	1.05
G16TSWU16	1	2.15	1.59	1.12	1.31	0.88	0.56	0.56	1-1/2	1-3/8	1.31

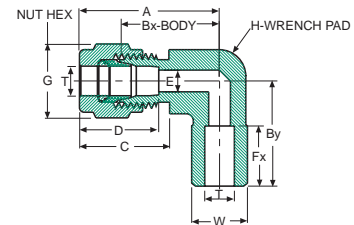

Tube Socket Weld Elbow (TSWE)

Griplok Part #	T Tube O.D.	A	Bx	By	C	D	E Minimum Opening	Fx	G	H	W
G4TSWE4	1/4	1.10	0.77	0.77	0.74	0.64	0.19	0.25	9/16	1/2	0.54
G6TSWE6	3/8	1.25	0.91	0.91	0.81	0.71	0.28	0.34	11/16	5/8	0.675
G8TSWE8	1/2	1.49	1.02	1.02	0.93	0.97	0.41	0.41	7/8	13/16	0.84

Griplok tube fittings with weld ends allow weld system connection to tubing with the advantage of a leak tight seal that can be disassembled in an otherwise permanently welded system. Weld ends conform to ANSI B31.1 and B31.3 piping codes.

Welding precautions: Prior to welding, remove the nut and ferrules. To protect the fitting body threads and seat, cover with a plug or another nut. Position a suitable heat sink to dissipate the heat. Insert the tube until bottomed out in the socket, then back out approximately 1/16" before welding.

Note: The welding of a bottomed tube may lead to stress cracking of the weld. To hold the fitting in proper alignment, tack weld the fitting in four places (90° apart) and then complete the weld. After welding, remove the protective plug or nut and replace with the nut and ferrules for tube installation following the instructions from page 6.

Finger-tight assembly dimensions (shown in inches) are for reference only and subject to change.

When ordering specify material designator with part number (see page 3 for complete ordering information).

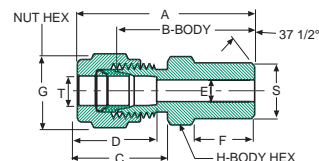

Male Pipe Weld Connector (MPWC)

Griplok Part #	T Tube O.D.	Male Pipe Weld Size	A	B	C	D	E Minimum Opening	F	G	H	S
G2MPWC2	1/8	1/8	1.26	0.94	0.66	0.56	0.09	0.38	7/16	7/16	0.405
G3MPWC2	3/16	1/8	1.28	0.97	0.68	0.59	0.12	0.38	1/2	7/16	0.405
G4MPWC2	1/4	1/8	1.33	1.00	0.74	0.64	0.19	0.38	9/16	1/2	0.405
G4MPWC4	1/4	1/4	1.53	1.20	0.74	0.64	0.19	0.56	9/16	9/16	0.540
G5MPWC2	5/16	1/8	1.34	1.05	0.73	0.64	0.20	0.38	5/8	9/16	0.405
G5MPWC4	5/16	1/4	1.52	1.23	0.73	0.64	0.25	0.56	5/8	9/16	0.540
G6MPWC4	3/8	1/4	1.62	1.28	0.81	0.71	0.28	0.56	11/16	5/8	0.540
G6MPWC6	3/8	3/8	1.62	1.28	0.81	0.71	0.28	0.56	11/16	11/16	0.675
G6MPWC8	3/8	1/2	1.87	1.53	0.81	0.71	0.28	0.75	11/16	7/8	0.840
G8MPWC6	1/2	3/8	1.78	1.31	0.93	0.97	0.41	0.56	7/8	13/16	0.675
G8MPWC8	1/2	1/2	2.00	1.53	0.93	0.97	0.41	0.75	7/8	7/8	0.840
G8MPWC12	1/2	3/4	2.06	1.59	0.93	0.97	0.41	0.75	7/8	1-1/16	1.050
G10MPWC8	5/8	1/2	1.97	1.53	0.90	1.00	0.50	0.75	1	15/16	0.840
G12MPWC12	3/4	3/4	2.03	1.59	0.90	1.00	0.62	0.75	1-1/8	1-1/16	1.050
G16MPWC16	1	1	2.53	1.97	1.12	1.31	0.86	0.94	1-1/2	1-3/8	1.315

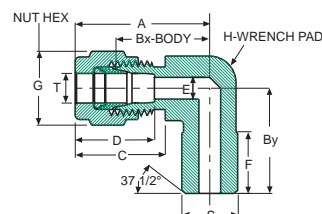

Male Pipe Weld Elbow (MPWE)

Griplok Part #	T Tube O.D.	Male Pipe Weld Size	A	Bx	By	C	D	E Minimum Opening	F	G	H	S
G4MPWE2	1/4	1/8	1.10	0.77	0.74	0.74	0.64	0.19	0.38	9/16	1/2	0.405
G4MPWE4	1/4	1/4	1.10	0.77	0.92	0.74	0.64	0.19	0.56	9/16	1/2	0.540
G6MPWE4	3/8	1/4	1.25	0.91	1.00	0.81	0.71	0.28	0.56	11/16	5/8	0.540
G8MPWE8	1/2	1/2	1.49	1.02	1.30	0.93	0.97	0.41	0.75	7/8	7/8	0.840
G12MPWE12	3/4	3/4	1.61	1.17	1.45	0.90	1.00	0.62	0.75	1-1/8	1-1/16	1.050

Finger-tight assembly dimensions (shown in inches) are for reference only and subject to change.

When ordering specify material designator with part number (see page 3 for complete ordering information).

Tube Stub Connectors/Adapters

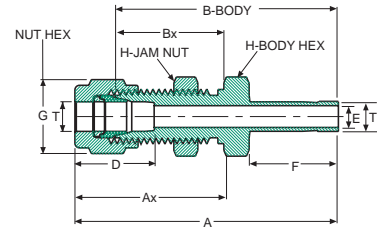

Bulkhead Reducer/Adapter (BR)

Griplok Part #	T Tube O.D.	A	Ax	B	Bx	D	E Minimum Opening	F	G	H	Maximum Panel Thickness	Panel Hole Drill Size
G2BR2	1/8	2.01	1.23	1.69	0.97	0.56	0.06	0.53	7/16	1/2	0.5	21/64
G4BR4	1/4	2.24	1.32	1.91	1.03	0.64	0.11	0.62	9/16	5/8	0.4	49/64
G6BR6	3/8	2.46	1.45	2.12	1.16	0.71	0.24	0.69	11/16	3/4	0.44	37/64
G8BR8	1/2	2.94	1.65	2.47	1.25	0.97	0.33	0.91	7/8	15/16	0.5	49/64

The Bulkhead Reducer / Adapter tube fitting provides the greatest connection flexibility in panel installations. The bulkhead reducer / adapter can be used with any proper size Griplok tube fitting configuration to meet the installers special requirements.

Finger-tight assembly dimensions (shown in inches) are for reference only and subject to change.
 When ordering specify material designator with part number (see page 3 for complete ordering information).

Tube Stub Connectors/Adapters

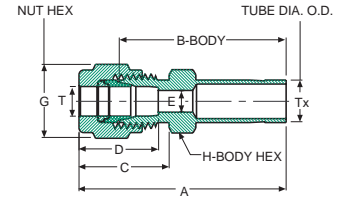

Reducer/Adapter* (R)

Griplik Part #	T Tube O.D.	Tx O.D.	A	B	C	D	E Minimum Opening	G	H
G1R2	1/16	1/8	1.21	1.00	0.49	0.40	0.06	5/16	5/16
G1R4	1/16	1/4	1.30	1.09	0.49	0.40	0.11	5/16	5/16
G2R1	1/8	1/16	1.20	0.88	0.66	0.56	0.02	7/16	7/16
G2R2	1/8	1/8	1.38	1.06	0.66	0.56	0.06	7/16	7/16
G2R3	1/8	3/16	1.41	1.09	0.66	0.56	0.08	7/16	7/16
G2R4	1/8	1/4	1.48	1.16	0.66	0.56	0.11	7/16	7/16
G2R6	1/8	3/8	1.54	1.22	0.66	0.56	0.24	7/16	7/16
G2R8	1/8	1/2	1.80	1.48	0.66	0.56	0.33	7/16	9/16
G3R2	3/16	1/8	1.42	1.11	0.68	0.59	0.06	1/2	7/16
G3R4	3/16	1/4	1.51	1.20	0.68	0.59	0.11	1/2	7/16
G4R2	1/4	1/8	1.49	1.16	0.74	0.64	0.06	9/16	1/2
G4R3	1/4	3/16	1.52	1.19	0.74	0.64	0.08	9/16	1/2
G4R4	1/4	1/4	1.58	1.25	0.74	0.64	0.11	9/16	1/2
G4R5	1/4	5/16	1.61	1.28	0.74	0.64	0.18	9/16	1/2
G4R6	1/4	3/8	1.64	1.31	0.74	0.64	0.24	9/16	1/2
G4R8	1/4	1/2	1.86	1.53	0.74	0.64	0.33	9/16	9/16
G4R10	1/4	5/8	1.93	1.60	0.74	0.64	0.42	9/16	11/16
G4R12	1/4	3/4	1.92	1.59	0.74	0.64	0.51	9/16	13/16
G5R6	5/16	3/8	1.65	1.36	0.73	0.64	0.24	5/8	9/16
G5R8	5/16	1/2	1.87	1.58	0.73	0.64	0.33	5/8	9/16
G6R4	3/8	1/4	1.68	1.34	0.81	0.71	0.15	11/16	5/8
G6R6	3/8	3/8	1.75	1.41	0.81	0.71	0.24	11/16	5/8
G6R8	3/8	1/2	1.96	1.62	0.81	0.71	0.33	11/16	5/8
G6R10	3/8	5/8	2.03	1.69	0.81	0.71	0.42	11/16	11/16
G6R12	3/8	3/4	2.03	1.69	0.81	0.71	0.51	11/16	13/16
G8R4	1/2	1/4	1.84	1.37	0.93	0.97	0.15	7/8	13/16
G8R6	1/2	3/8	1.91	1.44	0.93	0.97	0.24	7/8	13/16
G8R8	1/2	1/2	2.13	1.66	0.93	0.97	0.33	7/8	13/16
G8R10	1/2	5/8	2.19	1.72	0.93	0.97	0.42	7/8	13/16
G8R12	1/2	3/4	2.19	1.72	0.93	0.97	0.51	7/8	13/16
G8R16	1/2	1	2.44	1.97	0.93	0.97	0.75	7/8	1-1/16
G10R12	5/8	3/4	2.19	1.75	0.90	1.00	0.51	1	15/16
G10R14	5/8	7/8	2.25	1.81	0.90	1.00	0.64	1	15/16
G10R16	5/8	1	2.44	2.00	0.90	1.00	0.75	1	1-1/16
G12R8	3/4	1/2	2.19	1.75	0.90	1.00	0.34	1-1/8	1-1/16
G12R16	3/4	1	2.50	2.06	0.90	1.00	0.75	1-1/8	1-1/16

***NOTE:** For Heat Exchanger Tee applications (see page 27), certain Reducer/ Adapter fittings can be “bored through” to accommodate a process tube’s insertion. Consult with the local distributor for further information on “bored through” Reducer/Adapter (RBT) fittings.

Tube Stub Connectors/Adapters

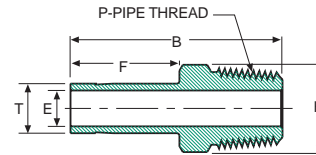
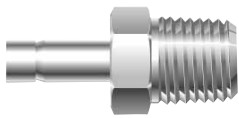

Male Adapter (MA)

Griplok Part #	T Tube O.D.	P-NPT Male Pipe Size	B	E Minimum Opening	F Min.	H
G2MA2	1/8	1/8	1.12	0.04	0.38	7/16
G2MA4	1/8	1/4	1.31	0.05	0.56	9/16
G3MA2	3/16	1/8	1.15	0.08	0.38	7/16
G3MA4	3/16	1/4	1.34	0.10	0.56	9/16
G4MA2	1/4	1/8	1.21	0.12	0.38	7/16
G4MA4	1/4	1/4	1.40	0.13	0.56	9/16
G4MA6	1/4	3/8	1.43	0.14	0.56	11/16
G4MA8	1/4	1/2	1.65	0.14	0.75	7/8
G5MA2	5/16	1/8	1.25	0.18	0.38	7/16
G5MA4	5/16	1/4	1.46	0.18	0.56	9/16
G6MA2	3/8	1/8	1.31	0.19	0.38	7/16
G6MA4	3/8	1/4	1.50	0.24	0.56	9/16
G6MA6	3/8	3/8	1.50	0.24	0.56	11/16
G6MA8	3/8	1/2	1.71	0.24	0.75	7/8
G8MA4	1/2	1/4	1.71	0.28	0.56	9/16
G8MA6	1/2	3/8	1.75	0.33	0.56	11/16
G8MA8	1/2	1/2	1.93	0.33	0.75	7/8
G10MA8	5/8	1/2	2.00	0.42	0.75	7/8
G12MA8	3/4	1/2	2.00	0.47	0.75	7/8
G12MA12	3/4	3/4	2.03	0.51	0.75	1-1/16
G16MA12	1	3/4	2.28	0.62	0.75	1-1/16
G16MA16	1	1	2.56	0.75	0.94	1-3/8

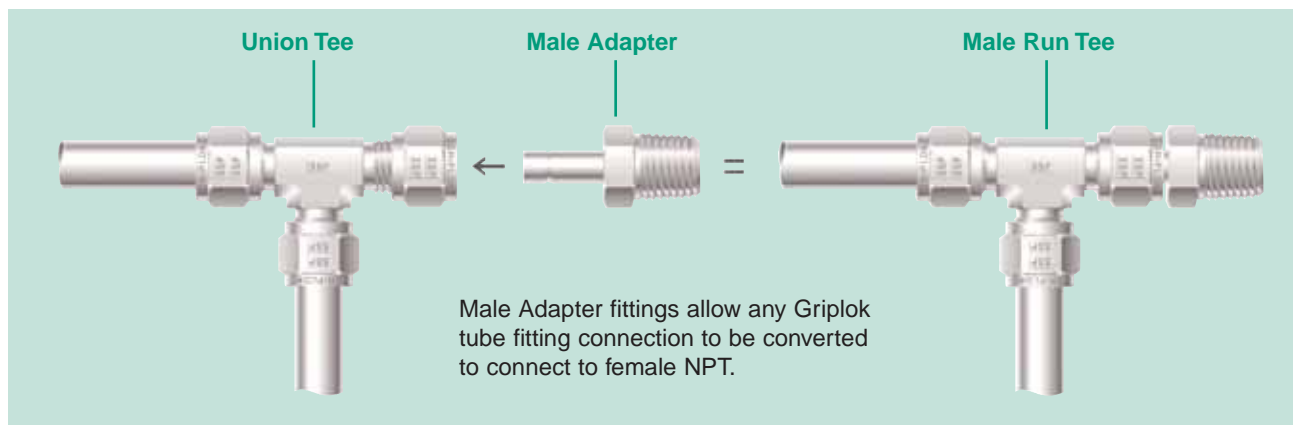

Finger-tight assembly dimensions (shown in inches) are for reference only and subject to change.
 When ordering specify material designator with part number (see page 3 for complete ordering information).

Tube Stub Connectors/Adapters

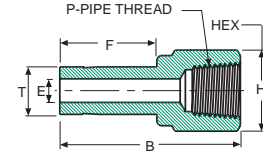

Female Adapter (FA)

Griplik Part #	T Tube O.D.	P-NPT Female Pipe Size	B	E Minimum Opening	F	H
G2FA2	1/8	1/8	1.23	0.07	0.53	9/16
G2FA4	1/8	1/4	1.34	0.07	0.53	3/4
G3FA4	3/16	1/4	1.37	0.12	0.56	3/4
G4FA2	1/4	1/8	1.32	0.18	0.62	9/16
G4FA4	1/4	1/4	1.43	0.18	0.62	3/4
G4FA6	1/4	3/8	1.56	0.18	0.62	7/8
G4FA8	1/4	1/2	1.46	0.18	0.62	1-1/16
G5FA4	5/16	1/4	1.46	0.25	0.65	3/4
G6FA2	3/8	1/8	1.39	0.28	0.68	9/16
G6FA4	3/8	1/4	1.50	0.28	0.68	3/4
G6FA6	3/8	3/8	1.62	0.28	0.68	7/8
G6FA8	3/8	1/2	1.84	0.28	0.68	1-1/16
G8FA4	1/2	1/4	1.71	0.39	0.90	3/4
G8FA6	1/2	3/8	1.84	0.39	0.90	7/8
G8FA8	1/2	1/2	2.06	0.39	0.90	1-1/16
G1.0FA8	5/8	1/2	2.12	0.50	0.96	1-1/16
G12FA8	3/4	1/2	2.12	0.59	0.96	1-1/16
G12FA12	3/4	3/4	2.18	0.59	0.96	1-5/16
G12FA16	3/4	1	2.46	0.59	0.96	1-5/8
G16FA12	1	3/4	2.43	0.95	1.21	1-1/4
G16FA16	1	1	2.71	0.95	1.21	1-5/8

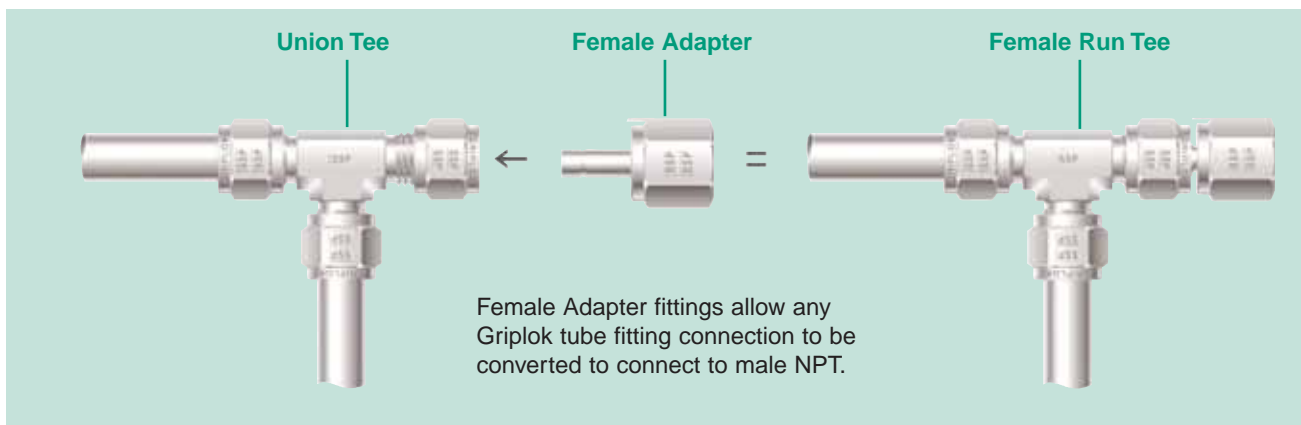

Finger-tight assembly dimensions (shown in inches) are for reference only and subject to change.
 When ordering specify material designator with part number (see page 3 for complete ordering information).

Tube Stub Connectors/Adapters

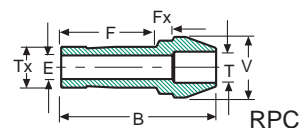
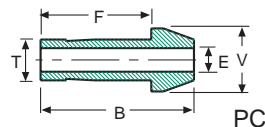

Port Connector (PC)

Griplik Part #	T Tube O.D.	B	E Minimum Opening	F	V
G1PC	1/16	0.54	0.02	0.42	0.13
G2PC	1/8	0.88	0.06	0.62	0.24
G4PC	1/4	0.97	0.11	0.74	0.37
G5PC	5/16	1.02	0.18	0.79	0.43
G6PC	3/8	1.03	0.24	0.80	0.50
G8PC	1/2	1.41	0.33	1.02	0.62
G12PC	3/4	1.47	0.51	1.09	0.87
G16PC	1	1.89	0.75	1.36	1.12

Reducing Port Connector (RPC)

Griplik Part #	T Tube O.D.	Tx Reduced Tube O.D.	B	E Minimum Opening	F	Fx	V
G2RPC1	1/8	1/16	0.68	0.02	0.34	0.08	0.24
G4RPC1	1/4	1/16	0.71	0.02	0.34	0.14	0.37
G4RPC2	1/4	1/8	0.89	0.06	0.53	0.13	0.37
G6RPC2	3/8	1/8	0.91	0.08	0.53	0.15	0.50
G6RPC4	3/8	1/4	0.98	0.15	0.62	0.13	0.50
G8RPC4	1/2	1/4	1.15	0.15	0.62	0.15	0.62
G8RPC6	1/2	3/8	1.20	0.24	0.69	0.13	0.62
G12RPC8	3/4	1/2	1.44	0.34	0.91	0.15	0.87

Port Connectors are used to close connect two Griplik tube fitting ports.

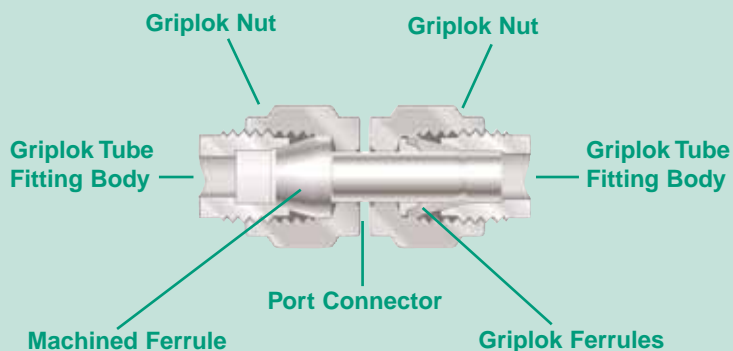

Installation Instructions for Port Connectors

- 1A. Remove the Griplik nut and ferrules from the first of the Griplik tube fitting parts to be close connected.
- 1B. Slide the Griplik nut (no ferrules) over the machined ferrule end of the port connector.
- 1C. Insert the machined ferrule end of the port connector into the Griplik tube fitting port and hand tighten the Griplik nut.
- 1D. While holding the tube fitting body steady with a backup wrench, tighten the Griplik nut with a wrench 1/4 turn.
2. Insert opposite end of the port connector into the second tube fitting port, hand tighten the Griplik nut, and while holding the tube fitting body steady with a backup wrench; wrench tighten the Griplik nut 1-1/4 turns for all sizes.

Finger-tight assembly dimensions (shown in inches) are for reference only and subject to change.
When ordering specify material designator with part number (see page 3 for complete ordering information).

Tube Stub Connectors/Adapters

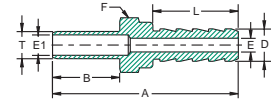

Hose Barb Adapter (HBA)

Griplok Part #	Hose I.D.	T Tube Size	A	B	D Dia.	E	E1	F Hex Flat	L
G2HBA2	1/8	1/8	1.35	0.63	0.15	0.08	0.09	5/16	0.40
G2HBA4	1/8	1/4	1.44	0.72	0.15	0.08	0.19	3/8	0.40
G4HBA4	1/4	1/4	1.83	0.72	0.30	0.19	0.19	7/16	0.79
G4HBA6	1/4	3/8	1.90	0.82	0.30	0.19	0.28	7/16	0.79
G5HBA4	5/16	1/4	1.91	0.72	0.37	0.19	0.19	7/16	0.87
G6HBA6	3/8	3/8	1.98	0.82	0.45	0.30	0.28	9/16	0.87
G6HBA8	3/8	1/2	2.20	1.00	0.45	0.30	0.39	5/8	0.87
G8HBA6	1/2	3/8	2.05	0.82	0.60	0.38	0.28	11/16	0.94
G8HBA8	1/2	1/2	2.27	1.00	0.60	0.38	0.39	11/16	0.94
G12HBA12	3/4	3/4	2.44	1.16	0.90	0.63	0.59	1 1/16	1.05

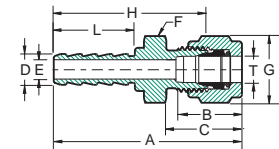

Hose Barb Connector (HBC)

Griplok Part #	Hose I.D.	T Tube Size	A	B	C	D Dia.	E Minimum Opening	F Hex Flat	G	H	L
G2HBC2	1/8	1/8	1.46	0.56	0.66	0.15	0.08	7/16	7/16	1.17	0.40
G4HBC2	1/4	1/8	1.85	0.64	0.74	0.30	0.09	7/16	9/16	1.56	0.79
G4HBC4	1/4	1/4	1.94	0.64	0.74	0.30	0.19	9/16	9/16	1.63	0.79
G6HBC4	3/8	1/4	2.01	0.71	0.81	0.45	0.19	9/16	11/16	1.70	0.87

Finger-tight assembly dimensions (shown in inches) are for reference only and subject to change.
 When ordering specify material designator with part number (see page 3 for complete ordering information).

Tube Stub Connectors/Adapters

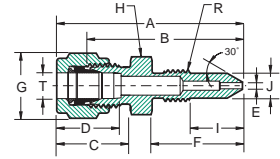

Calibration Union (CU1)

Griplok Part #	T Tube O.D.	A	B Body	C	D	E Minimum Opening	F	G Nut Hex	H Body Hex	I	J	R Thread
G4CU1	1/4	1.73	1.40	0.74	0.64	0.06	0.78	9/16	1/2	0.43	0.20	1/4-28 UNF



Calibration Union (CU2)

Griplok Part #	T Tube O.D.	A	B Body	C	D	E Minimum Opening	Fx	Fy	G	H Body Hex	I	J	R Thread
G4CU2	1/4	2.36	2.03	0.74	0.64	0.06	0.41	1	9/16	1/2	0.40	0.25	5/16-24 UNF

SSP Instrumentation Calibration Unions streamline the typical DP transmitter calibration process and are available in 1/4" OD tubing by 1/4-28 straight thread, and 1/4" OD tubing by 5/16-24 straight thread. Calibration unions screw directly into plug/bleed port fittings, eliminating the possibility of galling the transmitter's threads. Standard fitting material is 316 stainless steel. For more information, consult your local distributor.

Finger-tight assembly dimensions (shown in inches) are for reference only and subject to change.
When ordering specify material designator with part number (see page 3 for complete ordering information).

Griplok to 37° Flare (AN)

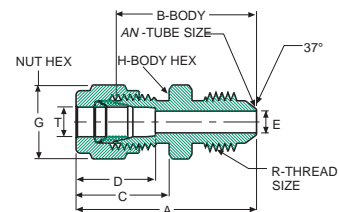
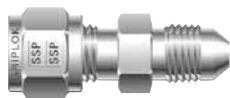

AN Union (ANU)

Griplok Part #	T Tube O.D.	AN Tube Flare Size	A	B	C	D	E Minimum Opening	G	H	R
G1ANU2	1/16	1/8	1.13	0.92	0.49	0.40	0.05	5/16	7/16	5/16 - 24UNJF-3
G2ANU2	1/8	1/8	1.33	1.01	0.66	0.56	0.06	7/16	7/16	5/16 - 24UNJF-3
G2ANU4	1/8	1/4	1.44	1.12	0.66	0.56	0.09	7/16	1/2	7/16 - 20UNJF-3
G4ANU4	1/4	1/4	1.52	1.19	0.74	0.64	0.17	9/16	1/2	7/16 - 20UNJF-3
G5ANU5	5/16	5/16	1.51	1.22	0.73	0.64	0.23	5/8	9/16	1/2 - 20UNJF-3
G6ANU4	3/8	1/4	1.61	1.27	0.81	0.71	0.17	11/16	5/8	7/16 - 20UNJF-3
G6ANU6	3/8	3/8	1.61	1.27	0.81	0.71	0.28	11/16	5/8	9/16 - 18UNJF-3
G8ANU8	1/2	1/2	1.88	1.41	0.93	0.97	0.39	7/8	1-3/16	3/4 - 16UNJF-3
G12ANU12	3/4	3/4	2.14	1.70	0.90	1.00	0.61	1-1/8	1-1/8	1-1/16 - 12UNJ-3
G16ANU16	1	1	2.50	1.94	1.12	1.31	0.84	1-1/2	1-3/8	1-5/16 - 12UNJ-3

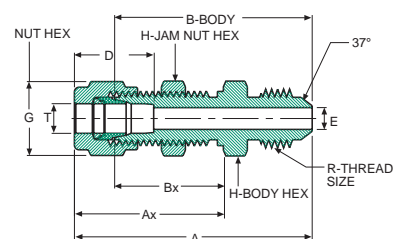
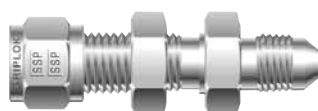

AN Bulkhead Union (ANBU)

Griplok Part #	T Tube O.D.	AN Tube Flare Size	A	Ax	B	Bx	D	E Minimum Opening	G	H	R	Maximum Panel Thickness	Panel Hole Drill Size
G4ANBU4	1/4	1/4	2.16	1.32	1.83	1.03	0.64	0.17	9/16	5/8	7/16 - 20UNJF-3	0.40	29/64
G6ANBU6	3/8	3/8	2.30	1.45	1.96	1.16	0.71	0.28	11/16	3/4	9/16 - 18UNJF-3	0.44	37/64
G8ANBU8	1/2	1/2	2.66	1.65	2.19	1.25	0.97	0.39	7/8	15/16	3/4 - 16UNJF-3	0.50	49/64
G12ANBU12	3/4	3/4	3.15	1.87	2.71	1.47	1.00	0.61	1-1/8	1-3/16	1-1/16 - 12UNJ-3	0.66	1 1/64
G16ANBU16	1	1	3.72	2.26	3.16	1.78	1.31	0.84	1-1/2	1-5/8	1-5/16 - 12UNJ-3	0.75	1 21/64

Finger-tight assembly dimensions (shown in inches) are for reference only and subject to change.
 When ordering specify material designator with part number (see page 3 for complete ordering information).

Griplok to 37° Flare (AN)

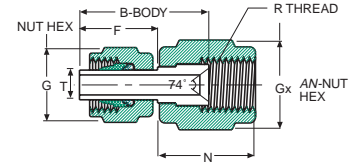

Female AN Adapter* (ANF)

Griplok Part #	T Tube O.D.	AN Tube O.D.	B	F	G Hex Flat	Gx Hex Flat	N	R AN Thread Size
G2ANF2	1/8	1/8	0.73	0.53	7/16	3/8	0.54	5/16-24 UNJF-3
G2ANF4	1/8	1/4	0.75	0.53	7/16	9/16	0.62	7/16-20 UNJF-3
G4ANF4	1/4	1/4	0.84	0.62	9/16	9/16	0.62	7/16-20 UNJF-3
G6ANF6	3/8	3/8	0.98	0.69	11/16	11/16	0.72	9/16-18 UNJF-3
G8ANF8	1/2	1/2	1.25	0.91	7/8	7/8	0.85	3/4-16 UNJF-3

* Follow Reassembly Instructions from page 6 for assembly of the Griplok end of the ANF fitting.

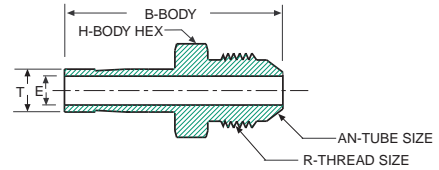

AN Adapter (ANA)

Griplok Part #	T Tube O.D.	AN Tube O.D.	A Overall Length	D AN Thread Size	E Minimum Opening	H Hex Flat
G4ANA4	1/4	1/4	1.46	7/16-20UNJF-3	0.17	1/2
G6ANA4	3/8	1/4	1.53	7/16-20UNJF-3	0.17	1/2
G6ANA6	3/8	3/8	1.56	9/16-18UNJF-3	0.26	5/8
G8ANA8	1/2	1/2	1.91	3/4-16UNJF-3	0.36	13/16
G12ANA12	3/4	3/4	2.21	1-1/16-12UNJF-3	0.59	1-1/8
G16ANA16	1	1	2.58	1-5/16-12UNJF-3	0.82	1-3/8

Finger-tight assembly dimensions (shown in inches) are for reference only and subject to change.

When ordering specify material designator with part number (see page 3 for complete ordering information).

Tube to O-Ring Seal

O-Ring Seal Connectors

Griplik O-Ring Seal Connectors provide a leak-tight seal in vacuum or pressure systems having tapered pipe or straight thread ports and a smooth, flat seat surface perpendicular to the axis of the threads. (See Figures 1-3). To produce an effective seal, the connectors are manufactured with a precision groove that retains the O-Ring and prevents its extrusion from the sealing area. The connectors are designed to seal upon a raised, flat surface or with a counter bored or recessed hole. The following O-Ring Seal installation instructions and mounting dimensions chart should be helpful when working with O-Ring Seal Connectors.

O-Ring Seal Connector Installation Instructions

1. Lubricate the O-Ring with a lubricant that is compatible with the O-Ring material and the system's media and environment. (Standard O-Ring material is BUNA Compound, 70 Durometer. Viton and other O-Ring compounds are available.)
2. Hand tighten the connector until the O-Ring begins to compress.
3. With a wrench, snug the connector to compress the O-Ring to the port and achieve the seal.
4. When connecting or disconnecting tubing to the Griplik fitting end of the connector, always use a back-up wrench to retain the connectors installed position.

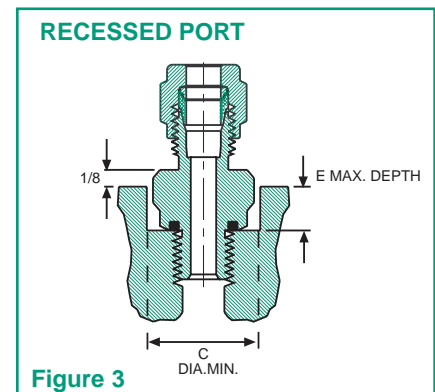
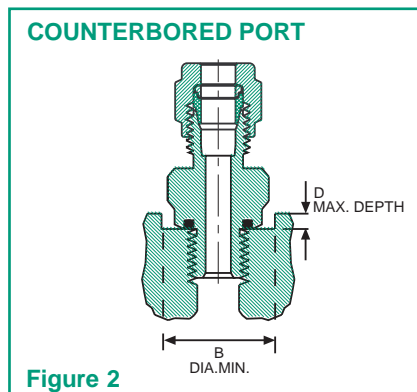
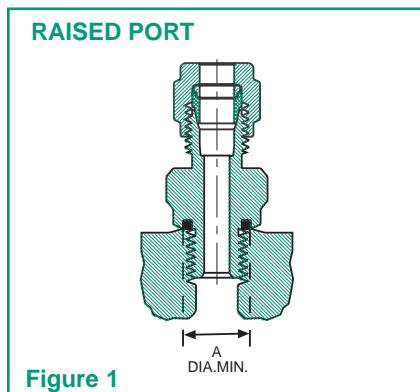

MOUNTING DIMENSIONS FOR O-RING SEAL CONNECTORS						
Pipe Thread Size	Straight Thread Size	Diameters			Depths	
		A Minimum Flat Surface for Sealing	B Minimum	C Minimum	D Maximum	E Maximum
1/8 NPT	-	0.69	0.78	0.88	0.16	0.28
1/4 NPT	-	0.87	0.97	1.09	0.16	0.31
3/8 NPT	-	1.00	1.16	1.31	0.16	0.34
1/2 NPT	-	1.00	1.34	1.53	0.22	0.44
-	5/16 - 24	0.50	0.59	0.66	0.09	0.16
-	3/8 - 24	0.56	0.66	0.75	0.09	0.22
-	7/16 - 20	0.69	0.78	0.88	0.16	0.28
-	1/2 - 20	0.75	0.91	1.03	0.16	0.31
-	9/16 - 18	0.81	0.97	1.09	0.16	0.31
-	3/4 - 16	1.00	1.16	1.31	0.16	0.34
-	1-1/16 - 12	1.41	1.53	1.75	0.22	0.50
-	1-5/16 - 12	1.69	1.78	2.03	0.22	0.56

Finger-tight assembly dimensions (shown in inches) are for reference only and subject to change.

When ordering specify material designator with part number (see page 3 for complete ordering information).

Tube to O-Ring Seal



(Connects to Female Short NPT Thread)

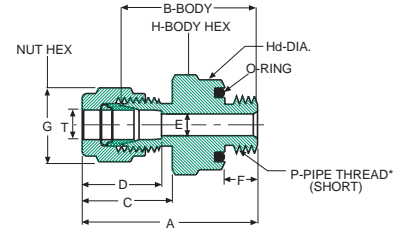

O-Ring Seal Male Connector (OMC)

Griplok Part #	T Tube O.D.	P-NPT Male Pipe Size*	A	B	C	D	E Minimum Opening	F	G	H	HD	AS568 O-Ring Uniform Size Number**
G2OMC2	1/8	1/8	1.35	1.03	0.66	0.56	0.09	0.28	7/16	3/4	0.74	-111
G4OMC2	1/4	1/8	1.42	1.09	0.74	0.64	0.19	0.28	9/16	3/4	0.74	-111
G4OMC4	1/4	1/4	1.55	1.22	0.74	0.64	0.19	0.38	9/16	15/16	0.93	-113
G6OMC4	3/8	1/4	1.62	1.28	0.81	0.71	0.28	0.38	11/16	15/16	0.93	-113
G6OMC6	3/8	3/8	1.68	1.34	0.81	0.71	0.28	0.41	11/16	1-1/8	1.12	-116
G6OMC8	3/8	1/2	1.90	1.56	0.81	0.71	0.28	0.53	11/16	1-5/16	1.3	-212
G8OMC8	1/2	1/2	2.03	1.56	0.93	0.97	0.41	0.53	7/8	1-5/16	1.3	-212

* Modified Male NPT to Allow O-Ring Seal Connection.

**70 Durometer BUNA compound O-Ring is standard. Other O-Ring compounds are available.



(Connects to Female Straight Thread)

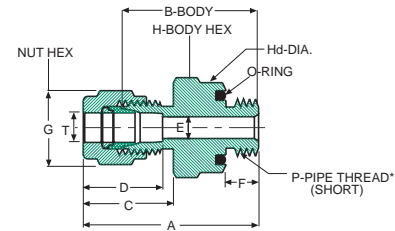

O-Ring Seal Male Straight Thread Connector (OSC)

Griplok Part #	T Tube O.D.	S Thread Size	A	B	C	D	E Minimum Opening	F	G	H	Hd	AS568 O-Ring Uniform Size Number*
G1OSC	1/16	5/16 - 24	1.11	0.90	0.49	0.40	0.05	0.34	5/16	9/16	0.55	-11
G2OSC	1/8	5/16 - 24	1.35	1.03	0.66	0.56	0.09	0.34	7/16	9/16	0.55	-11
G3OSC	3/16	3/8 - 24	1.40	1.09	0.68	0.59	0.12	0.38	1/2	5/8	0.62	-12
G4OSC	1/4	7/16 - 20	1.55	1.22	0.74	0.64	0.19	0.41	9/16	3/4	0.74	-111
G5OSC	5/16	1/2 - 20	1.60	1.31	0.73	0.64	0.25	0.44	5/8	7/8	0.86	-112
G6OSC	3/8	9/16 - 18	1.72	1.38	0.81	0.71	0.28	0.47	11/16	15/16	0.93	-113
G8OSC	1/2	3/4 - 16	1.88	1.41	0.93	0.97	0.41	0.47	7/8	1-1/8	1.12	-116
G12OSC	3/4	1 1/16 - 12	2.10	1.66	0.90	1.00	0.62	0.56	1-1/8	1-1/2	1.49	-215
G16OSC	1	1 5/16 - 12	2.37	1.81	1.12	1.31	0.88	0.56	1-1/2	1-3/4	1.74	-219

*70 Durometer BUNA compound O-Ring is standard. Other O-Ring compounds are available.

Finger-tight assembly dimensions (shown in inches) are for reference only and subject to change.

When ordering specify material designator with part number (see page 3 for complete ordering information).



These fittings adapt to SAE/J1926 (Straight Thread Boss) and MS16142

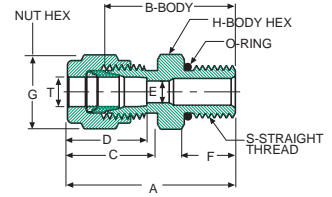

Male Connector - Straight Thread Boss (MCST)

Griplok Part #	T Tube O.D.	S Thread Size	A	B	C	E Minimum Opening	F	G	H	AS568O-Ring Uniform Size Number*
G2MCST2	1/8	5/16 -24	1.24	0.92	0.66	0.09	0.30	7/16	7/16	-902
G4MCST4	1/4	7/16 -20	1.38	1.05	0.74	0.19	0.36	9/16	9/16	-904
G4MCST6	1/4	9/16 -18	1.44	1.11	0.74	0.19	0.39	9/16	11/16	-906
G4MCST8	1/4	3/4 -16	1.52	1.19	0.74	0.19	0.44	9/16	7/8	-908
G4MCST10	1/4	7/8 -14	1.64	1.31	0.74	0.19	0.50	9/16	1	-910
G5MCST5	5/16	1/2 -20	1.37	1.08	0.73	0.25	0.36	5/8	5/8	-905
G6MCST4	3/8	7/16 -20	1.45	1.11	0.81	0.20	0.36	11/16	5/8	-904
G6MCST6	3/8	9/16 -18	1.51	1.17	0.81	0.28	0.39	11/16	11/16	-906
G6MCST8	3/8	3/4 -16	1.59	1.25	0.81	0.28	0.44	11/16	7/8	-908
G6MCST10	3/8	7/8 -14	1.71	1.37	0.81	0.28	0.50	11/16	1	-910
G8MCST6	1/2	9/16 -18	1.61	1.14	0.93	0.28	0.39	7/8	13/16	-906
G8MCST8	1/2	3/4 -16	1.72	1.25	0.93	0.41	0.44	7/8	7/8	-908
G8MCST10	1/2	7/8 -14	1.84	1.37	0.93	0.41	0.50	7/8	1	-910
G8MCST12	1/2	1 1/16 -12	2.00	1.53	0.93	0.41	0.59	7/8	1-1/4	-912
G10MCST8	5/8	3/4 -16	1.69	1.25	0.90	0.42	0.44	1	15/16	-908
G10MCST10	5/8	7/8 -14	1.82	1.38	0.90	0.50	0.50	1	1	-910
G12MCST8	3/4	3/4 -16	1.85	1.41	0.90	0.42	0.44	1-1/8	1-1/16	-908
G12MCST12	3/4	1 1/16 -12	1.97	1.53	0.90	0.62	0.59	1-1/8	1-1/4	-912
G14MCST14	7/8	1 3/16 -12	1.97	1.53	0.90	0.72	0.59	1-1/4	1-3/8	-914
G16MCST12	1	1 1/16 -12	2.18	1.62	1.12	0.66	0.59	1-1/2	1-3/8	-912
G16MCST16	1	1 5/16 -12	2.22	1.66	1.12	0.88	0.59	1-1/2	1-1/2	-916

*90 Durometer BUNA compound O-Ring is standard. Other O-Ring compounds are available.

Tube to SAE/MS

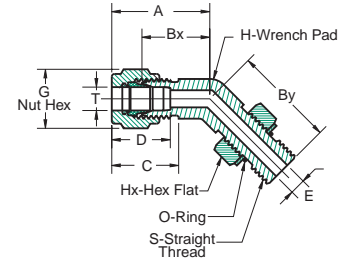

45° Male Elbow - Straight Thread Boss (M45EST)

Griplok Part #	T Tube O.D.	S SAE/MS Thread Size	A	C	D	E Min. Opening	H Wrench Pad	Hx Hex Flat	G Hex Flat	Bx	By	AS568 O-Ring Uniform Size Number*
G4M45EST4	1/4	7/16-20	1.01	0.70	0.60	0.19	1/2	9/16	9/16	0.72	1.01	-904
G6M45EST6	3/8	9/16-18	1.10	0.76	0.66	0.28	5/8	11/16	11/16	0.81	1.11	-906
G8M45EST8	1/2	3/4-16	1.26	0.86	0.90	0.41	13/16	7/8	7/8	0.86	1.27	-908
G12M45EST12	3/4	1-1/16 - 12	1.57	0.86	0.96	0.62	1-1/8	1-1/4	1-1/8	1.17	1.86	-912
G16M45EST16	1	1-5/16 - 12	1.87	1.04	1.23	0.88	1-3/8	1-1/2	1-1/2	1.39	1.99	-916

*90 Durometer BUNA compound O-Ring is standard. Other O-Ring compounds are available.

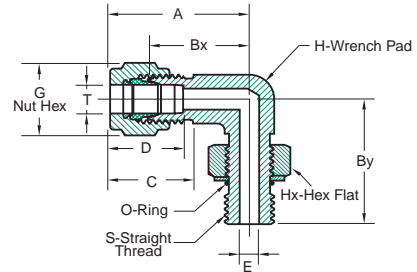

Male Elbow - Straight Thread Boss (MEST)

Griplok Part #	T Tube O.D.	S SAE/MS Thread Size	A	C	D	E Min. Opening	H Wrench Pad	Hx Hex Flat	G Hex Flat	Bx	By	AS568 O-Ring Uniform Size Number*
G4MEST4	1/4	7/16-20	1.12	0.70	0.60	0.19	1/2	9/16	9/16	0.83	1.12	-904
G4MEST6	1/4	9/16-18	1.20	0.70	0.60	0.19	5/8	11/16	9/16	0.91	1.27	-906
G5MEST5	5/16	1/2-20	1.19	0.73	0.64	0.23	9/16	5/8	5/8	0.90	1.16	-905
G6MEST4	3/8	7/16-20	1.26	0.76	0.66	0.28	9/16	9/16	11/16	0.97	1.15	-904
G6MEST6	3/8	9/16-18	1.26	0.76	0.66	0.28	9/16	11/16	11/16	0.97	1.27	-906
G6MEST8	3/8	3/4-16	1.37	0.76	0.66	0.28	3/4	7/8	11/16	1.08	1.49	-908
G8MEST6	1/2	9/16-18	1.48	0.86	0.90	0.41	3/4	11/16	7/8	1.08	1.27	-906
G8MEST8	1/2	3/4-16	1.48	0.86	0.90	0.41	13/16	7/8	7/8	1.08	1.49	-908
G10MEST10	5/8	7/8-14	1.56	0.86	0.96	0.50	15/16	1	1	1.16	1.71	-910
G12MEST12	3/4	1-1/16 - 12	1.63	0.86	0.96	0.62	1-1/16	1-1/4	1-1/8	1.23	1.92	-912
G16MEST16	1	1-5/16 - 12	1.99	1.04	1.23	0.88	1-3/8	1-1/2	1-1/2	1.51	2.11	-916

*90 Durometer BUNA compound O-Ring is standard. Other O-Ring compounds are available.

Finger-tight assembly dimensions (shown in inches) are for reference only and subject to change.

When ordering specify material designator with part number (see page 3 for complete ordering information).

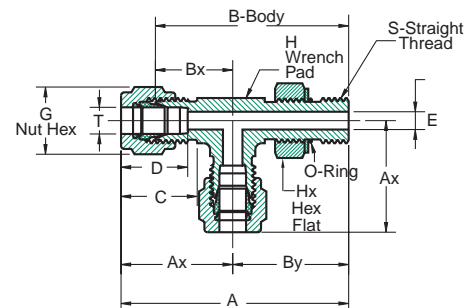

Male Run Tee - Straight Thread Boss (MRTST)

Griplok Part #	T Tube O.D.	S SAE/MS Thread Size	A	Ax	C	D	E Min. Opening	H Wrench Pad	Hx Hex Flat	G Hex Flat	B	Bx	By	AS568 O-Ring Uniform Size Number*
G4MRTST4	1/4	7/16-20	2.24	1.12	0.70	0.60	0.19	1/2	9/16	9/16	1.95	0.83	1.12	-904
G6MRTST6	3/8	9/16-18	2.53	1.26	0.76	0.66	0.28	5/8	11/16	11/16	2.24	0.97	1.27	-906
G8MRTST8	1/2	3/4-16	2.97	1.48	0.86	0.90	0.41	13/16	7/8	7/8	2.57	1.08	1.49	-908
G12MRTST12	3/4	1-1/16 - 12	3.55	1.63	0.86	0.96	0.62	1-1/16	1-1/4	1-1/8	3.15	1.23	1.92	-912
G16MRTST16	1	1-5/16 - 12	4.10	1.99	1.04	1.23	0.88	1-3/8	1-1/2	1-1/2	3.62	1.51	2.11	-916

*90 Durometer BUNA compound O-Ring is standard. Other O-Ring compounds are available.

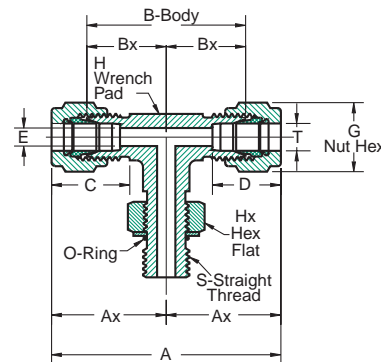

Male Branch Tee - Straight Thread Boss (MBTST)

Griplok Part #	T Tube O.D.	S SAE/MS Thread Size	A	Ax	C	D	E Min. Opening	H Wrench Pad	Hx Hex Flat	G Hex Flat	B	Bx	AS568 O-Ring Uniform Size Number*
G4MBTST4	1/4	7/16-20	2.24	1.12	0.70	0.60	0.19	1/2	9/16	9/16	1.66	0.83	-904
G6MBTST6	3/8	9/16-18	2.52	1.26	0.76	0.66	0.28	5/8	11/16	11/16	1.94	0.97	-906
G8MBTST8	1/2	3/4-16	2.96	1.48	0.86	0.90	0.41	13/16	7/8	7/8	2.16	1.08	-908
G12MBTST12	3/4	1-1/16 - 12	3.26	1.63	0.86	0.96	0.62	1-1/16	1-1/4	1-1/8	2.46	1.23	-912
G16MBTST16	1	1-5/16 - 12	3.98	1.99	1.04	1.23	0.88	1-3/8	1-1/2	1-1/2	3.02	1.51	-916

*90 Durometer BUNA compound O-Ring is standard. Other O-Ring compounds are available.

Finger-tight assembly dimensions (shown in inches) are for reference only and subject to change.

When ordering specify material designator with part number (see page 3 for complete ordering information).

Tube to SAE/MS

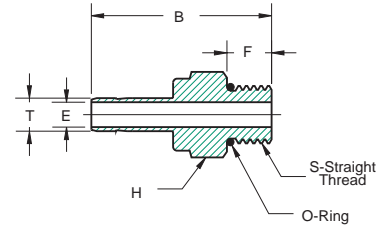

Male Adapter - Straight Thread Boss (MAST)

Griplok Part #	T Tube O.D.	S SAE/MS Thread Size	B	F	E Min. Opening	H Hex Flat	AS568 O-Ring Uniform Size Number*
G2MAST2	1/8	5/16-24	1.20	0.30	0.09	7/16	-902
G4MAST4	1/4	7/16-20	1.39	0.36	0.19	9/16	-904
G6MAST4	3/8	7/16-20	1.46	0.36	0.19	9/16	-904
G6MAST6	3/8	9/16-18	1.52	0.39	0.28	11/16	-906
G6MAST8	3/8	3/4-16	1.60	0.44	0.28	7/8	-908
G8MAST6	1/2	9/16-18	1.74	0.39	0.39	11/16	-906
G8MAST8	1/2	3/4-16	1.82	0.44	0.39	7/8	-908
G12MAST12	3/4	1-1/16 - 12	2.10	0.59	0.59	1-1/4	-912
G16MAST16	1	1-5/16 - 12	2.41	0.59	0.80	1-1/2	-916

*90 Durometer BUNA compound O-Ring is standard. Other O-Ring compounds are available.

Finger-tight assembly dimensions (shown in inches) are for reference only and subject to change.
When ordering specify material designator with part number (see page 3 for complete ordering information).



Caps are used for capping the end of a tubing run

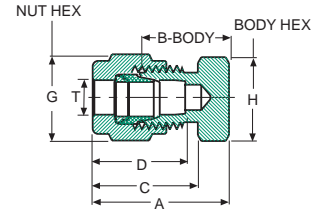

Cap (CP)

Griplok Part #	T Tube O.D.	A	B	C	D	G	H
G1CP	1/16	0.65	0.44	0.49	0.40	5/16	5/16
G2CP	1/8	0.85	0.53	0.66	0.56	7/16	7/16
G3CP	3/16	0.89	0.58	0.68	0.59	1/2	7/16
G4CP	1/4	0.96	0.63	0.74	0.64	9/16	1/2
G5CP	5/16	0.96	0.67	0.73	0.64	5/8	9/16
G6CP	3/8	1.06	0.72	0.81	0.71	11/16	5/8
G8CP	1/2	1.22	0.75	0.93	0.97	7/8	13/16
G10CP	5/8	1.22	0.78	0.90	1.00	1	15/16
G12CP	3/4	1.28	0.84	0.90	1.00	1-1/8	1-1/16
G14CP	7/8	1.38	0.94	0.90	1.06	1-1/4	1-3/16
G16CP	1	1.59	1.03	1.12	1.31	1-1/2	1-3/8

Cap Installation Instructions

The standard Griplok tube fitting installation instructions apply for proper installation of caps (see page 6).



Plugs are used to plug an unused port of a Griplok tube fitting

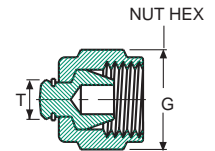

Plug (P)

Griplok Part #	T Tube O.D.	G
G1P	1/16	5/16
G2P	1/8	7/16
G3P	3/16	1/2
G4P	1/4	9/16
G5P	5/16	5/8
G6P	3/8	11/16
G8P	1/2	7/8
G10P	5/8	1
G12P	3/4	1-1/8
G16P	1	1-1/2

Plug Installation Instructions

1. Remove the nut and ferrules from the port of the tube fitting body to be plugged and replace with the Griplok plug.
2. Hand-tighten the Griplok plug and then while holding the tube fitting body steady with a back-up wrench, use a wrench to tighten the Griplok plug only 1/4 of a turn.



Finger-tight assembly dimensions (shown in inches) are for reference only and subject to change.

When ordering specify material designator with part number (see page 3 for complete ordering information).

Components

Nut (N)

Griplik Part #	T - Tube O.D.	G	L
G1N	1/16	5/16	0.31
G2N	1/8	7/16	0.47
G3N	3/16	1/2	0.47
G4N	1/4	9/16	0.50
G5N	5/16	5/8	0.53
G6N	3/8	11/16	0.56
G8N	1/2	7/8	0.69
G10N	5/8	1	0.69
G12N	3/4	1-1/8	0.69
G14N	7/8	1-1/4	0.69
G16N	1	1-1/2	0.81

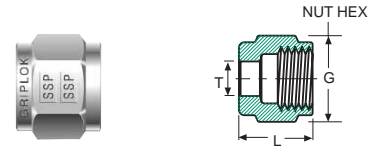

Rear Ferrule (RF)

Griplik Part #	T - Tube O.D.
G1RF	1/1 6
G2RF	1/8
G3RF	3/1 6
G4RF	1/4
G5RF	5/1 6
G6RF	3/8
G8RF	1/2
G10RF	5/8
G12RF	3/4
G14RF	7/8
G16RF	1



Front Ferrule (FF)

Griplik Part #	T - Tube O.D.
G1FF	1/16
G2FF	1/8
G3FF	3/16
G4FF	1/4
G5FF	5/16
G6FF	3/8
G8FF	1/2
G10FF	5/8
G12FF	3/4
G14FF	7/8
G16FF	1



Ferrule Set (FS)

Griplik Part #	T - Tube O.D.
G1FS	1/16
G2FS	1/8
G3FS	3/16
G4FS	1/4
G5FS	5/16
G6FS	3/8
G8FS	1/2
G10FS	5/8
G12FS	3/4
G14FS	7/8
G16FS	1



A Ferrule Set (FS) consists of one front ferrule and one rear ferrule and is conveniently packaged and sold in multiples of ten sets per "holding tube" housing. To order twenty (20) sets of the 1/4" 316 Stainless Steel front and rear ferrules, specify: 20 pcs. **ISSG4FS**

Finger-tight assembly dimensions (shown in inches) are for reference only and subject to change.
When ordering specify material designator with part number (see page 3 for complete ordering information).

Knurled Nut (KN)

Griplok Part #	T Tube O.D.	G	L
G1KN	1/16	5/16	0.31
G2KN	1/8	7/16	0.47
G3KN	3/16	1/2	0.47
G4KN	1/4	9/16	0.50
G5KN	5/16	5/8	0.53
G6KN	3/8	11/16	0.56
G8KN	1/2	7/8	0.69
G10KN	5/8	1	0.69
G12KN	3/4	1-1/8	0.69
G14KN	7/8	1-1/4	0.69
G16KN	1	1-1/2	0.81



The knurled nut is designed for use with fittings used in applications where it has been determined by the user that a finger tight assembly procedure is acceptable. Typical applications include low pressure laboratory use of plastic tubing.

Bulkhead Locknut (BN)

Griplok Part #	T Tube O.D.	A	H
G1BN	1/16	0.22	5/16
G2BN	1/8	0.24	1/2
G3BN	3/16	0.27	9/16
G4BN	1/4	0.28	5/8
G5BN	5/16	0.24	11/16
G6BN	3/8	0.29	3/4
G8BN	1/2	0.35	15/16
G10BN	5/8	0.36	1-1/16
G12BN	3/4	0.39	1-3/16
G14BN	7/8	0.45	1-3/8
G16BN	1	0.55	1-5/8

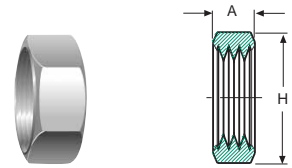

Tube Insert (TI)

Griplok Part #	T Tube O.D.	Tube I.D.	E I.D. of Bore
G 3TI2	3/16	1/8	0.09
G 4TI2	1/4	1/8	0.09
G 4TI170	1/4	.170	0.11
G 4TI3	1/4	3/16	0.14
G 5TI2	5/16	1/8	0.09
G 5TI3	5/16	3/16	0.12
G 5TI4	5/16	1/4	0.19
G 6TI3	3/8	3/16	0.12
G 6TI4	3/8	1/4	0.19
G 8TI4	1/2	1/4	0.19
G 8TI6	1/2	3/8	0.31
G 10TI6	5/8	3/8	0.31
G 10TI8	5/8	1/2	0.44
G 12TI8	3/4	1/2	0.44
G 12TI10	3/4	5/8	0.56
G 16TI12	1	3/4	0.69

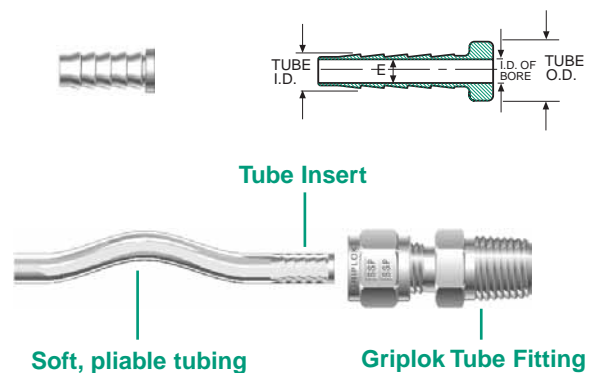

In general, Griplok tube fittings may be used with a variety of plastic tube materials without any special preparations. However, very soft-wall, pliable tubing such as Tygon® needs a tube insert for support prior to insertion in the Griplok tube fitting. The standard Griplok tube fitting installation instructions (see page 6) are then followed for proper make-up.

Finger-tight assembly dimensions (shown in inches) are for reference only and subject to change.
When ordering specify material designator with part number (see page 3 for complete ordering information).

SSP flareless instrumentation quality tube fittings have been designed and manufactured to provide leak free connections in a wide variety of applications. The design characteristics of the tube fittings compensate for many of the field variables involved in the installation of the tube fittings and with the tolerances, wall thickness, finish and quality of the tubing. A reliable leak free tubing system will be achieved by combining the proper selection and handling of tubing with the proper tube fitting selection and installation. The following information is provided to assist in the tube selection process.

MATERIAL

The tubing material chosen must be compatible with the system's contained media, pressure and temperature, as well as with the environment in which it will be installed. Also, the tubing and tube fitting materials should be similar for optimum sealing action to occur (stainless fittings for stainless tube, brass fittings for copper tube, carbon steel fittings for carbon steel tube, etc.) The mixing and contact of dissimilar materials may leave the system susceptible to galvanic corrosion and/or not allow proper tube fitting make up to be achieved. Additionally, the tube fittings have been designed and manufactured to function within the hardness ranges allowed for similar tubing material by applicable ASTM specifications as referred to in Tables 1-4.

PRESSURE AND FLOW

The size of the tube's outside diameter (O.D.) and the necessary wall thickness are determined by the systems pressure and flow requirements. Tables 1-4 detail the suggested tubing sizes and wall thicknesses for use with instrument tube fittings. Additionally, the tables provide the maximum allowable working pressures for each size of tube recommended for use with instrument tube fittings. If no pressure is shown on the table for a particular size, the tube is not recommended for use with instrumentation tube fittings. The tubing system should not be utilized above the tube's maximum allowable working pressure; however, instrument tube fittings have been tested as leak tight to the burst pressure of the tubing in all recommended sizes and wall thickness.

TEMPERATURE

The system's operating temperature may effect the initial choice of tubing material and may also effect the maximum allowable working pressure for the given tube size (see Table 5 for temperature stress factors).

LIGHT GAS SERVICE

Light gasses such as hydrogen, helium, nitrogen, etc. have extremely small molecules which can be released through the smallest of leak paths including tubing surface imperfections or defects. To provide a successful connection for light gas service, the tubing must have a thick enough wall to provide resistance for the setup action of the ferrules to further compensate for the tube's potential surface condition. Tables 1-4 show the tubing sizes and wall thicknesses recommended for light gas service.

HANDLING AND INSTALLATION

Surface scratches and gouges on tubing are a source of potential leaks. Some precaution when handling the tubing can help reduce surface scratches and maintain the surface finish as originally intended by the manufacturer. Tubing should never be dragged across rocks, blacktop, pavement or the tubing storage rack as scratches and gouges can occur. Sharp blades should always be used in the tube cutters or hacksaws used to cut the tubing as to provide a clean square cut. Dull cutting blades can cause internal and external hanging burrs, and cause the tubing to become oval and effect proper insertion within the fitting. As a good handling practice, tubing should always be deburred prior to tube fitting installation to help assure easy and complete tube insertion. Additionally, for bent tube assemblies, it is important to bend tubing prior to installing tube fittings, and to provide a sufficient straight length of tubing after the bend to allow the tube to be fully inserted into the fitting. See Figure A and Table 7 on page 53 for additional information. Also, to eliminate weight stress from the tubing upon the fitting and to provide additional system support for vibration and thermal shock resistance, the tubing should always be supported by tube hangers, clamps or trays.

Selection Guide for Instrumentation Fittings & Tubing

STAINLESS STEEL TUBING - TABLE 1																	
Maximum Allowable Working Pressure (PSIG)																	
Tube O.D. Size (in.)	Wall Thickness of Tube																
	.010	.012	.014	.016	.020	.028	.035	.049	.065	.083	.095	.109	.120	.134	.156	.188	
1/16	5600	6850	8150	9500	12100												
1/8						8550	11000										Note: For light gas service, use tubing with wall thickness outside of screened area.
3/16						5450	7000	10300									
1/4						4000	5100	7500	10300								
5/16							4050	5850	8050								
3/8							3300	4800	6550								
1/2							2450	3500	4750	6250							
5/8								2950	4000	5200	6050						
3/4								2400	3300	4250	4950	5800					
7/8								2050	2800	3600	4200	4850					
1									2400	3150	3650	4200	4700				
1-1/4										2450	2850	3300	3650	4150	4900		
1-1/2											2350	2700	3000	3400	4000	4900	
2												2000	2200	2500	2900	3600	

Calculation Basis: Annealed, seamless 304 or 316 stainless steel tubing ASTM A-269 or equivalent. System temperatures between -20°F and 100°F with allowable stress of 20,000 psi. Ultimate tensile strength of 75,000 psi. Safety factor of 4.

Reference: ANSI B31.3 Code. (For more specific working pressure information regarding a particular tubing, consult with the actual manufacturer of the tubing.)

Note: For welded and drawn tubing, a derating factor must be utilized. For double welded tube, multiply the above pressure rating by .85; and for single welded tube .80 (ANSI B 31, Table A-1B).

Suggested Tube Ordering Information: Specify the outside diameter and wall thickness of annealed, seamless or welded and drawn 316 or 304 stainless steel tubing of ASTM A-269, A-249, A-213 or equivalent. Also specify high quality tubing to be free of scratches, and suited for bending with material hardness not to exceed Rb 90.

COPPER TUBING - TABLE 2								
Maximum Allowable Working Pressure								
Tube O.D. Size (in.)	Wall Thickness of Tube (Inches)							
	.028	.035	.049	.065	.083	.095	.109	.120
1/8	2700	3600						
3/16	1700	2225	3450					Note: For light gas service, use tubing with wall thickness outside of screened area.
1/4	1250	1600	2475	3475				
5/16		1250	1900	2675				
3/8		1050	1550	2150				
1/2		750	1150	1550	2050			
5/8			900	1200	1600	1850		
3/4			700	1000	1275	1500	1775	
7/8			600	850	1075	1250	1500	
1			550	700	950	1100	1300	1400

Calculation Basis: Annealed (Temper 060), seamless copper tubing ASTM B-75 or equivalent. System temperatures between -20°F and 100°F with allowable stress of 6000 psi. Safety factor of 5.

Reference: ANSI B 31.3 Code. (For more specific working pressure information regarding a particular tubing, consult with the actual manufacturer of the tubing.)

Suggested Tube Ordering Information: Specify the outside diameter and wall thickness of annealed (Temper 060), seamless copper tubing of ASTM B-75, B-68, or equivalent specification. Also specify high quality tubing to be free of scratches, and suited for bending.

Additionally acceptable: Annealed (Temper O) copper water tubing, Type K, or Type L (ASTM B-88). No embossed markings allowed.

Finger-tight assembly dimensions (shown in inches) are for reference only and subject to change.

When ordering specify material designator with part number (see page 3 for complete ordering information).

Selection Guide for Instrumentation Fittings & Tubing

CARBON STEEL TUBING - TABLE 3													
Maximum Allowable Working Pressure (PSIG)													
Tube O.D. Size (in.)	Wall Thickness of Tube (Inches)												
	.028	.035	.049	.065	.083	.095	.109	.120	.134	.148	.165	.180	.220
1/8	8100	10500											
3/16	5150	6700	9900										
1/4	3750	4850	7100	9900									
5/16		3800	5500	7600									
3/8		3100	4500	6200									
1/2		2300	3300	4500	5950								
5/8		1800	2600	3500	4600	5350							
3/4			2150	2900	3750	4375	5100						
7/8			1800	2450	3200	3700	4300						
1			1550	2100	2750	3200	3700	4125					
1-1/4				1650	2150	2500	2900	3200	3600	4050	4600	5000	
1-1/2					1800	2000	2400	2600	3000	3300	3700	4100	5100
2						1500	1700	1900	2200	2400	2700	3000	3700

Calculation Basis: Annealed, seamless carbon steel tubing ASTM A-179 or equivalent. System temperatures between -20°F and 100°F with allowable stress of 15,700 psi. Ultimate tensile strength of 47,500 psi. Safety factor of 4.

Reference: ANSI B31.3 Code. (For more specific working pressure information regarding a particular tubing, consult with the actual manufacturer of the tubing.)

Suggested Tube Ordering Information: Specify the outside diameter and wall thickness of annealed, seamless carbon steel tubing of ASTM A-179 or equivalent specification. Also specify high quality tubing to be free of scratches, and suited for bending with material hardness not to exceed Rb 72.

MONEL® ALLOY 400 TUBING - TABLE 4								
Maximum Allowable Working Pressure (PSIG)								
Tube O.D. Size (in.)	Wall Thickness of Tube (Inches)							
	.028	.035	.049	.065	.083	.095	.109	.120
1/8	8000	10450						
1/4	3750	4800	7000	9800				
3/8		3100	4450	6150				
1/2		2300	3300	4450				
3/4			2250	3050	4000	4600		
1				2250	2900	3400	3900	4350

Monel 400 is a trademark of INCO Alloys International Incorporated.

Calculation Basis: Annealed, seamless Monel Alloy 400 tubing ASTM B-165 or equivalent. System temperatures between -20°F and 100°F with allowable stress of 18,700 psi. Ultimate tensile strength of 70,000 psi. Safety factor of 4.

Reference: ANSI B31.3 Code. (For more specific working pressure information regarding a particular tubing, consult with the actual manufacturer of the tubing.)

Suggested Tube Ordering Information: Specify the outside diameter and wall thickness of annealed, seamless Monel Alloy 400 tubing of ASTM B-165 or equivalent specification. Also specify high quality tubing to be free of scratches, and suited for bending with material hardness not to exceed Rb 75.

Finger-tight assembly dimensions (shown in inches) are for reference only and subject to change.

When ordering specify material designator with part number (see page 3 for complete ordering information).

STRESS FACTORS FOR DETERMINING TUBING PRESSURE						
RATINGS AT ELEVATED TEMPERATURES-TABLE 5						
TEMPERATURE STRESS FACTORS						
Temperature		Stainless Steel		Carbon Steel	Copper	Monel® 400
°F	°C	304SS	316SS			
100	38	1.00	1.00	1.00	1.00	1.00
200	93	1.00	1.00	0.96	0.80	0.88
300	149	1.00	1.00	0.90	0.78	0.82
400	204	0.94	0.97	0.86	0.50	0.79
500	260	0.88	0.90	0.82	n/a	0.79
600	316	0.82	0.85	0.77	n/a	0.79
700	371	0.80	0.82	0.73	n/a	0.79
800	427	0.76*	0.80*	0.59	n/a	0.76
900	482	0.73*	0.78*	0.41	n/a	0.43
1000	538	0.69*	0.73*	0.16	n/a	n/a
1200	649	0.30*	0.37*	n/a	n/a	n/a

* The precipitation of chromium carbides potentially resulting in intergranular corrosion may occur when exposed to operating temperatures above 800°F. Consult the factory for further information.
Monel 400 is a trademark of INCO Alloys International Incorporated.

Instructions: To determine maximum allowable working pressure for tubing at elevated temperatures, multiply the applicable tube's maximum allowable working pressure from Table 1-4 by the corresponding temperature stress factor from Table 5.

SSP NPT PIPE END PRESSURE RATINGS, ANSI/ASME B 31.3 - TABLE 6													
NPT/ISO Pipe Size	Size	316 STAINLESS STEEL				BRASS				CARBON STEEL			
		Male		Female		Male		Female		Male		Female	
		psig	bar	psig	bar	psig	bar	psig	bar	psig	bar	psig	bar
1/16"	1	11,050	760	6,750	460	5,550	380	3,350	230	11,050	760	6,750	460
1/8"	2	10,050	690	6,550	450	5,050	350	3,250	220	10,050	690	6,550	450
1/4"	4	8,050	550	6,650	460	4,050	280	3,350	230	8,050	550	6,650	460
3/8"	6	7,850	540	5,350	370	3,950	270	2,650	180	7,850	540	5,350	370
1/2"	8	7,750	530	4,950	340	3,850	260	2,450	170	7,750	530	4,950	340
3/4"	12	7,350	510	4,650	320	3,650	250	2,350	160	7,350	510	4,650	320
1"	16	5,350	370	4,450	310	2,650	180	2,250	150	5,350	370	4,450	310
Reference: bar = .0690 X psig				To obtain ANSI/ASME B 31.1 values, multiply ANSI/ASME B 31.3 values by .94.									

INSTALLING TUBE FITTINGS NEAR TUBE BENDS

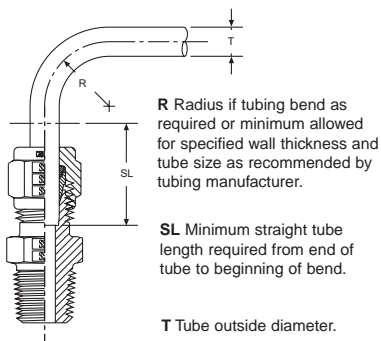

FIGURE A

When installing fittings near tube bends, it is important to **bend tubing prior to installing tube fittings** and there must be a sufficient straight length (SL) of tubing to allow the tube to be bottomed in the fitting. Note Table 7 for details.

TABLE 7

T = Tube O.D. (in.)	1/16"	1/8"	3/16"	1/4"	5/16"	3/8"	1/2"	5/8"	3/4"	7/8"	1"
*SL= Minimum Straight Length of Tube (in.)	1/2"	3/4"	3/4"	13/16"	7/8"	15/16"	1-3/16"	1-1/4"	1-1/4"	1-5/16"	1-9/16"
R	Radius of tube bend as recommended by bender manufacturer										

* Consult the factory on an application by application basis for variance.



IMPROPER SELECTION OR IMPROPER USE OF THE PRODUCTS DESCRIBED HEREIN OR RELATED ITEMS CAN CAUSE PERSONAL INJURY AND PROPERTY DAMAGE.

It is the sole responsibility of the system designers and users to properly select and use products for their specific applications. This document has been printed for users with technical expertise as a reference for further investigation to determine specific product needs relative to design requirements.

Finger-tight assembly dimensions (shown in inches) are for reference only and subject to change.

When ordering specify material designator with part number (see page 3 for complete ordering information).

Safety Information/Warranty

Safety

To help ensure the safe and reliable performance of tube fitting products, complete system design must be considered prior to the installation of the tubing and tube fittings. Determining the design compatibility of materials, media, flows, temperatures and pressures; as well as implementing proper installation, operation and maintenance of the system are the responsibility of the systems' owners, designers and users.

SSP Safety Reminders

All SSP products are designed and manufactured with safety in mind. The following is a limited list of general safety practices:

Do not install, tighten or loosen a tube fitting while the system is under pressure.

Do not loosen a tube fitting, nut or plug to relieve or bleed system pressure.

Always use a back-up wrench to hold the tube fitting body steady when tightening or loosening tube fitting nuts.

There is no need to disassemble a new tube fitting prior to use.

Use proper thread lubricants and sealants on tapered pipe threads.

Very soft, pliable plastic tubing requires a tube insert.

Tube fitting and tubing material should be similar (stainless steel fittings on stainless steel tubing, brass fittings on copper tubing, etc.) with the tubing material being fully annealed. For more specific information, refer to the Selection Guide for Instrumentation Tubing on pages 51-53.

Do not weld tube fittings that are assembled. Prior to welding, remove the nut and ferrules and protect the seat and thread area of the tube fitting by covering with a plug or another nut.

Griplok[®] Tube Fittings LIFETIME LIMITED WARRANTY

SSP guarantees all Griplok tube fittings and Griplok tube fitting components to be free from defects in materials and workmanship. Additionally, SSP guarantees Griplok product performance to the published catalog specifications when properly installed according to the catalog selection and installation instructions. To initiate a warranty claim, suspected defective product must be returned to SSP with the nature of potential defect documented for factory evaluation. Any product with a determined defect in material or workmanship will be replaced with an equivalent product at no charge.

This warranty comprises the sole and entire warranty pertaining to items provided hereunder. There is no other warranty, guarantee, express or implied representation of any kind whatsoever. All other warranties including, but not limited to, merchantability and fitness for purpose, whether express, implied, or arising by operation of law. Course of dealing, or trade usage are hereby disclaimed. There are no warranties which extend beyond the description on the face hereof; and this warranty does not apply in the case of abuse, mishandling, or normal use depreciation. In no event, whether alleged to arise from breach of contract, express or implied warranty, by operation of law, negligence or otherwise, will SSP be liable for any incidental, consequential, lost property, or other special damages of any kind whatsoever. The exclusive remedy under this warranty is the replacement of determined defective parts as set forth above.

Finger-tight assembly dimensions (shown in inches) are for reference only and subject to change.

When ordering specify material designator with part number (see page 3 for complete ordering information).

In addition to Griplok tube fittings, SSP offers Duolok and Unilok tube fittings, TruFit pipe, weld and adapter fittings, TruFit Hose assemblies, connectors, adapters and accessories and FloLok Valves. Contact your SSP Instrumentation Distributor for more information.

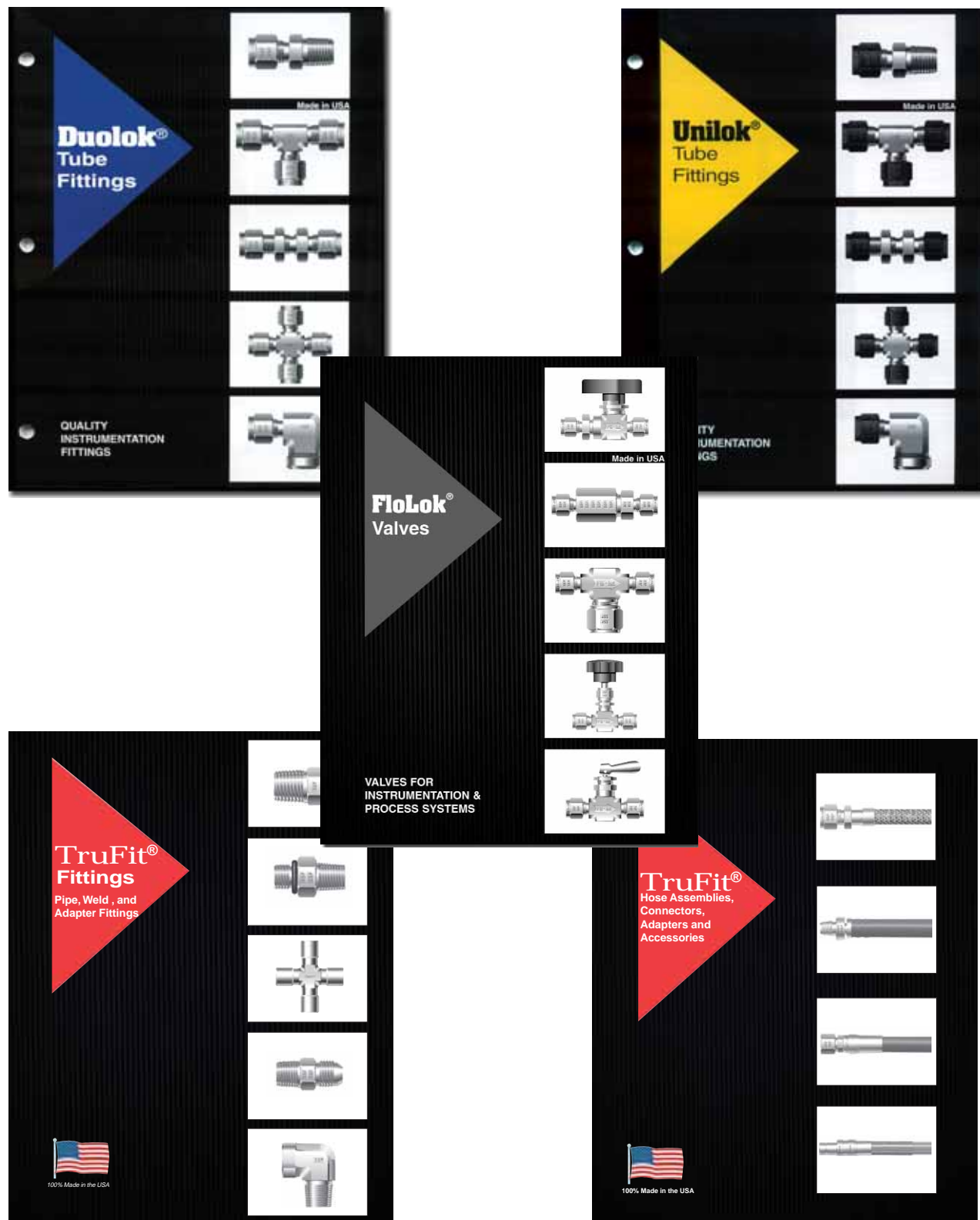

Finger-tight assembly dimensions (shown in inches) are for reference only and subject to change.
When ordering specify material designator with part number (see page 3 for complete ordering information).

Griplok® Tube Fittings

AUTHORIZED DISTRIBUTOR:

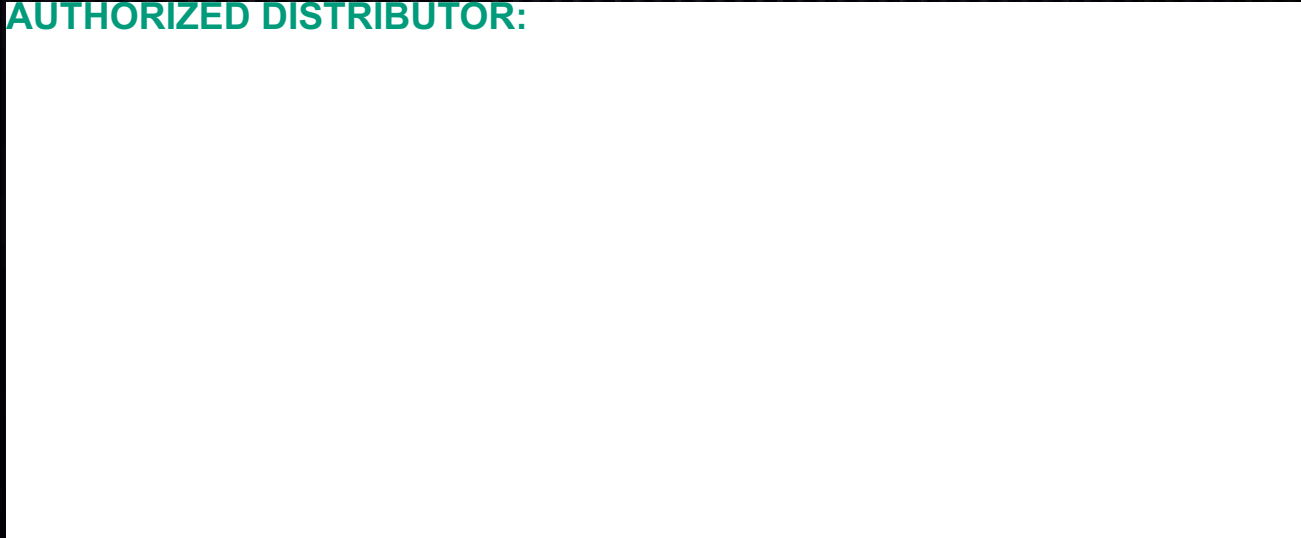

SSP Instrumentation

8250 Boyle Pkwy
Twinsburg, OH 44087-2200
P: 330.425.4250
F: 330.425.8116



Made in the USA

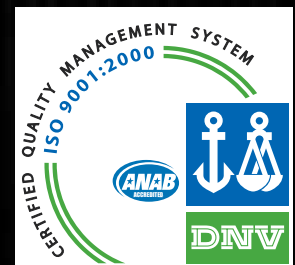

ILGPC-/050-07A
©2007, SSP Fittings Corp.