

Initial Installation

- 1 SSP tube fittings come individually bagged and completely assembled for immediate use. There is no need for disassembly prior to use. Simply remove the tube fitting from its bag, insert the tube* until it bottoms in the SSP tube fitting body and then hand tighten the SSP nut. (See Figure 02.)

*Tubing ends should be cut as straight as possible with all O.D. and I.D. burrs removed. Use of a tubing cutter or guide blocks with a hack-saw is recommended.

Figure 02.

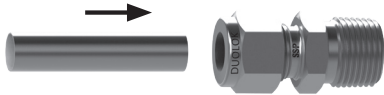

NOTE: For extreme system applications using high pressures or requiring an extra factor of safety, it may be desirable to use a "common make up starting point" to alleviate the inherent variations in tubing diameters. Installation should begin from a snug position, which is achieved by wrench tightening the Duolok nut until the inserted tubing will not move by hand (approximately 1/8 turn). From this new "snug" starting point, continue with the recommended installation instructions.

- 2 While holding the fitting body stable with a back-up wrench, scribe the nut for a reference point and wrench tighten the nut 1-1/4 turns for sizes 1/4" to 1" and 3/4 turn for sizes 1/16" to 3/16". (See Figures 03 and 04 in the next column.)

NOTE: For all sizes, tighten plugs (P), machined ferrule end of port connector (PC) and the SSP tube fitting end of the Female AN adapter (ANF) only 1/4 of a turn. SSP recommends 3/4 in. and larger tube fittings be preswaged using a hydraulic swaging tool for installation. Contact your local SSP Distributor for more information.

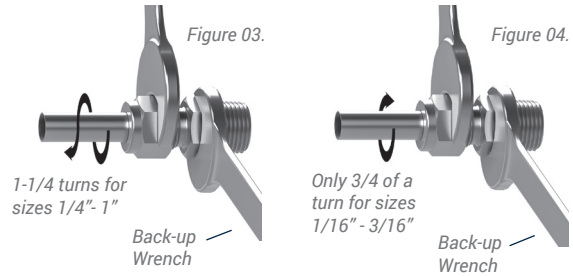

Reassembly Instructions

- 1 To reassemble a SSP tube fitting connection, simply insert the tubing with the previously coined ferrules and SSP nut into the fitting body until the front ferrule seats within the fitting body, and then tighten the nut by hand. (See Figure 05.)

Figure 05.

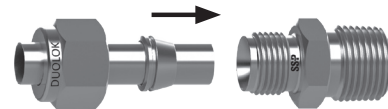

NOTE: By following proper reassembly procedures, SSP tube fitting connections may be disconnected and reconnected repeatedly.

- 2 While holding the fitting body stable with a back up wrench, use a wrench to rotate the SSP nut to the fitting's original installation position (approximately 1/4 turn from the hand-tight, snug position) then continue to tighten the SSP nut slightly. (See Figure 06.)

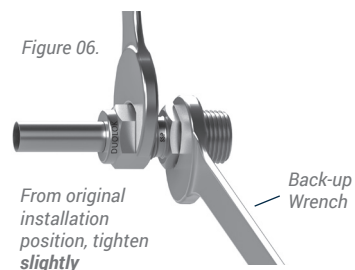

Component Assembly

Should individual component assembly of a SSP tube fitting ever be required, careful attention must be given to the proper sequence and direction of the SSP tube fitting components. (See Figure 07.)

Figure 07.

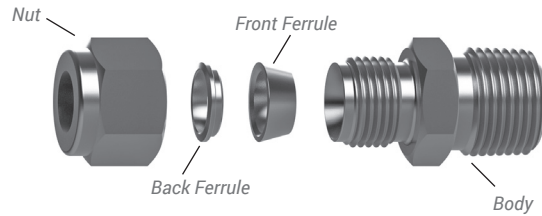

Pre-setting

The SSP tube fitting pre-setting tool is used to preset the ferrules on the tubing for subsequent installation in a fitting body. The pre-setting tool can be especially helpful when an installation must be made in a tight space or hard-to-work area. The pre-setting tool allows the major portion of the installation work to occur in a more favorable work setting with only the completion of the installation in the hard-to-work area.

Pre-setting Instructions

- 1 Secure the pre-setting tool in a vise.
- 2 Remove the protective nut, and assemble the SSP nut and ferrules loosely to the pre-setting tool. Insert the tubing through the nut and ferrules until it bottoms in the pre-setting tool, and then follow the standard SSP tube fitting installation instructions from page 1. (See Figures 08a and 08b.)

Figure 08a.

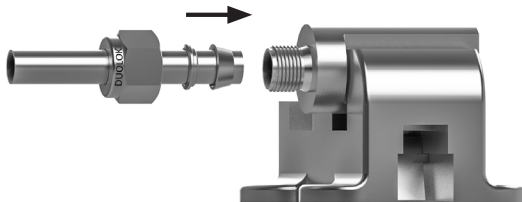
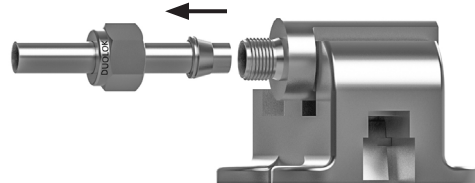

Figure 08b.



- 3 Loosen the nut and remove the tubing with the pre-set SSP tube fitting ferrules and nut from the pre-setting tool. (See Figure 09.)

Figure 09.



- 4 Installation of the tubing, with the pre-set SSP tube fitting ferrules and nut in the appropriate fitting body can now be made by following the standard reassembly instructions from page 1. (See Figures 10a and 10b.)

Figure 10a.

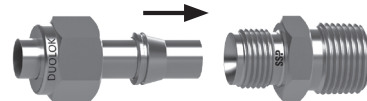
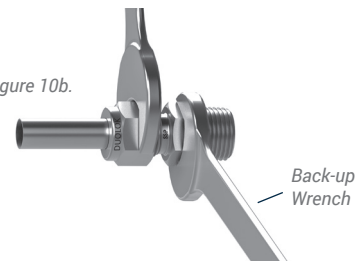

Figure 10b.



- 5 Return the protective nut to the pre-setting tool.

NOTE: To extend the life of a pre-setting tool, lubricate the tool with a lubricant compatible with the system's tubing material, environment and media. Also, at times an over-sized or very soft tubing may tend to stick in the pre-setting tool after make up. To remove the tubing, gently rock the tubing back and forth. Never turn the tube with pliers or another tool as such action may damage the sealing surfaces.

Gageability

Each SSP tube fitting component is manufactured with utmost precision to provide the optimum performance interaction of the components during assembly. By maintaining such stringent manufacturing tolerances, SSP tube fittings are considered gageable for sufficient pull-up during initial installation. The SSP tube fitting “Gap Gages” are designed to identify for the installer or inspector, prior to pressurizing a system, that sufficient tightening of the tube fitting has occurred. Gageability provides additional reliability for proper installation and ultimate tube fitting safety and performance.

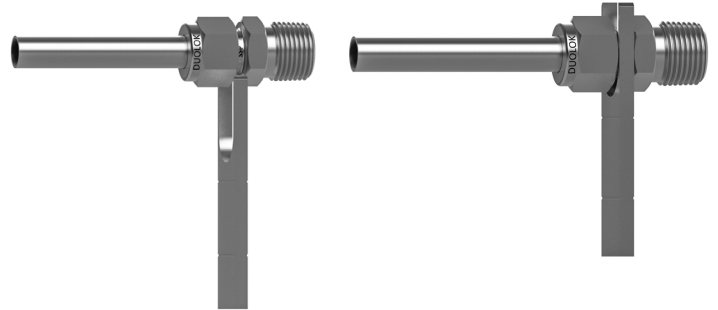

No additional tightening required.

Additional tightening required.

Gap Gage Instructions

- ① Follow proper installation instructions (as supplied with the fittings, or published in the SSP tube fittings catalog).
- ② After completion of the installation instructions and prior to pressuring the system, choose the proper size Gap Gage and try to insert it between the fitting's nut and body hex. (See Figure 11.)
- ③ If the Gap Gage will not enter between the fitting's nut and body hex, no additional tightening is required.
- ④ If the Gap Gage will enter between the fitting's nut and body hex, additional tightening is required.

NOTE: Swagelok Gap Inspection Gages may also be utilized effectively with Duolok tube fittings.